

Spare Parts List

GARUDAN[®]

GF-118 Serie



ANITA B, s.r.o.

Hliníky 2068

680 01 Boskovice

Czech Republic

tel: +420 516454774, 516453496

fax: +420 516452751

e-mail: info@anita.cz

Note:

M..... GF-118-143 LM
M-7..... GF-118-146 LM
GF-118-147 LM

L..... GF-116-143 LM
L-7..... GF-116-146 LM
GF-116-147 LM

www.garudan.cz

CONTENTS

A	<i>Machine Body & Thread Tension Adjusting Mechanism</i> 외장 및 실장력 조절 관계.....	4
B	<i>Upper Shaft & Thread Take Up Lever Mechanism</i> 상축 및 실채기 관계.....	6
C	<i>Upright Shaft & Lower Shaft Mechanism</i> 세운축 및 하축 관계.....	7
D	<i>Feed Mechanism</i> 피이드 관계.....	8
E	<i>Thread Trimmer Mechanism</i> 사절 관계.....	12
F	<i>Mes Driving Mechanism</i> 메스 구동 관계.....	14
G	<i>Needle Bar & Needle Bar Driving Mechanism</i> 바늘대 및 바늘대 요동 관계.....	16
H	<i>Presser Foot & Tension Release Mechanism</i> 노루발 및 실 늦추기 관계.....	18
I	<i>Thread Wiper Mechanism</i> 와이퍼 관계.....	20
J	<i>Reverse Button Mechanism</i> 역진 버튼 관계.....	21
K	<i>Program Unit Box & Auto Presser Lifting Solenoid Mechanism</i> 프로그램 유닛 박스 및 자동 무릎 올림 관계.....	22
L	<i>Lubrication</i> 급유 관계.....	23
M	<i>Accessories</i> 액세서리.....	24
N	<i>Special Parts For</i>	26
O	<i>Gauge Parts</i> 게이지 관계.....	27

NOTE : Parts are Subject to change in Design Without Prior Notice.

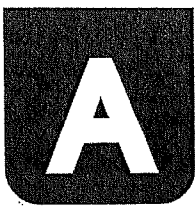

Machine Body & Thread Tension Adjusting Mechanism

외장 및 실장력 조절 관계

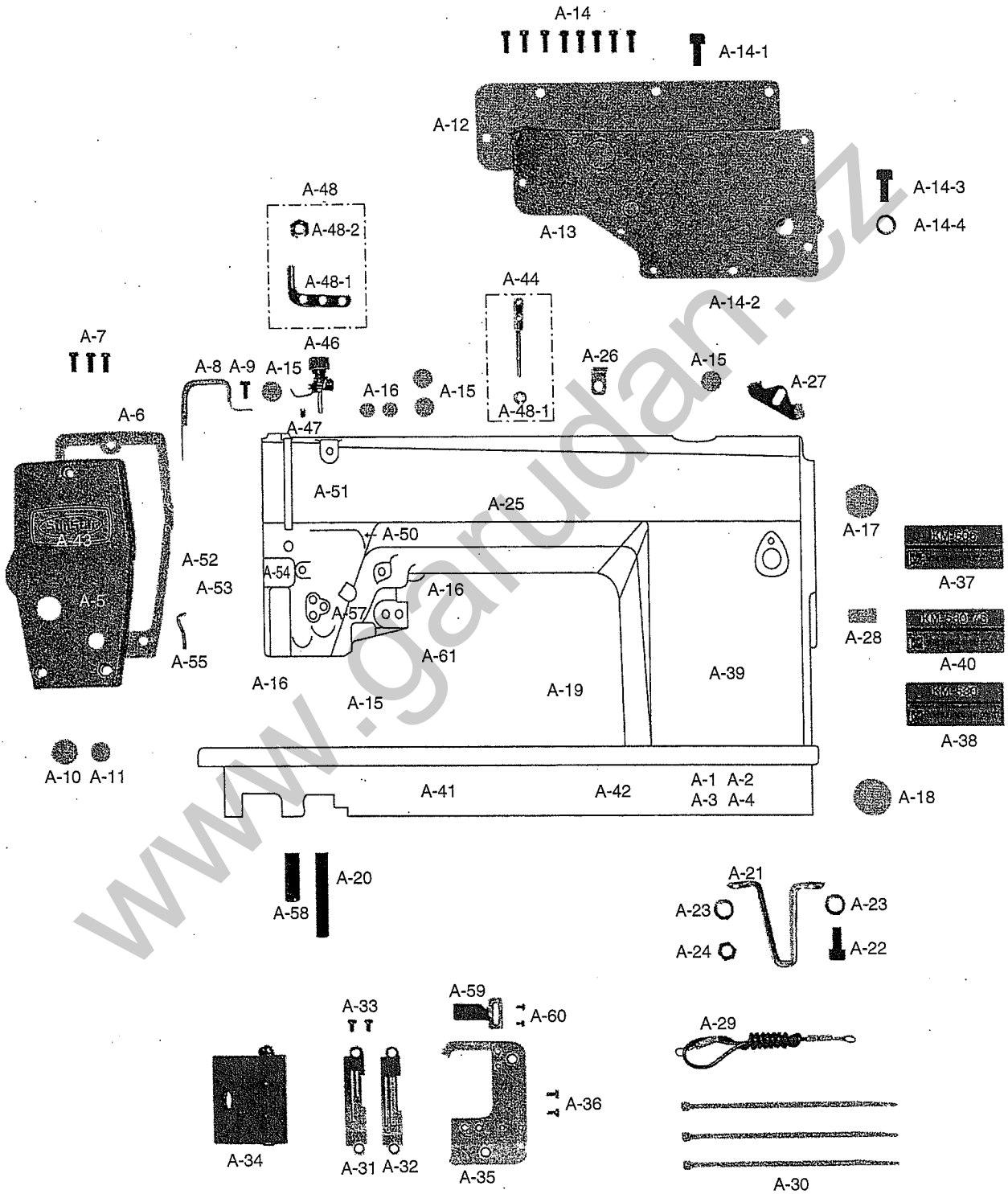

Ref.No	Parts No	Note	Name of Parts	품명	Q'ty	Assembly No
A-1	01-001A-5060	L	Arm, Bed	아암 베드	1	
A-2	01-001A-5300	M	Arm, Bed	아암 베드	1	
A-3	01-001A-5067	L-7	Arm, Bed	아암 베드	1	
A-4	01-001A-5307	M-7	Arm, Bed	아암 베드	1	
A-5	01-041C-3500		Face Plate	면판	1	
A-6	01-042M-3500		Gasket For A-5	면판 가스켓	1	
A-7	SC-0523-1230		Screw (3/16" n=28)	무릎올림 링크고정나사(3/16" n=28)	3	
A-8	01-139C-2500		Take Up Lever Cover	실채기 커버	1	
A-9	SC-0548-7400		Screw (3/16" n=28)	다이알판 쥘나사(3/16" n=28)	1	
A-10	01-144R-1230		Face Plate Rubber Cap(L)	면판 고무마개 (대) 흰색(3-1)	1	
A-11	01-110R-1230		Face Plate Rubber Cap(S)	면판 고무마개 (중) 흰색(3)	1	
A-12	01-140C-2500		Back Cover	뒷뚜껑(STD)	1	
A-13	01-241M-2500		Gasket For Back Cover	뒷뚜껑 가스켓	1	
A-14	SC-0548-7400	L, M	Screw (3/16" n=28)	다이알판 쥘나사(3/16" n=28)	8	
A-14-1	SC-0523-1230	L-7, M-7	Screw (3/16" n=28)	무릎올림 링크 고정나사	3	
A-14-2	SC-0548-7400	L-7, M-7	Screw (3/16" n=28)	다이알판 쥘나사	5	
A-14-3	SC-0215-1230	L-7, M-7	Screw (9/64" n=40)	톱카바나사(조)	1	
A-14-4	SC-019W-1230	L-7, M-7	Screw (9/64" n=40)	상측 헬트 와셔	1	
A-15	01-110R-1230		Arm Rubber Cap(L)	면판 고무마개 (중) 흰색(3)	4	
A-16	04-003R-1600		Arm Rubber Cap(S)	고무마개 (소)	2	
A-17	01-008R-3400	M, M-7	Rubber Cap For F-15	면판 급유마개	1	
A-18	01-021R-1600		Bed Rubber Cap	하측 후봇싱 고무마개	1	
A-19	01-005A-257A	L-7, M-7	Code Bushing	코드 붓싱	1	
A-20	01-016C-1230		Bed Base "FRONT"(A)	베드 받침 (前)	1	
A-21	01-115C-1230		Bed Leg Right	베드 받침	1	
A-22	SC-0346-2350		Screw (M8×1.25)	베드 받침 후결합볼트(M8×1.25)	1	
A-23	01-038W-1230		Spring Washer For A-21	베드 받침 스프링 와셔	2	
A-24	SN-0112-1230		Nut(M8×1.25)	베드 받침 너트(M8×1.25)	1	
A-25	01-010M-2350		Brand Mark	상표 마크(암부)	1	
A-26	01-142A-257A	L-7, M-7	Code Holder "A"	코드 잠이"A"	1	
A-27	01-143A-257A	L-7, M-7	Code Holder "B"	코드 잠이"B"	1	
A-28	01-009R-5300	L-7, M-7	Cable Holder(7N)	케이블 잠이A (6N)	1	
A-29	12-016M-2350	L-7, M-7	Earth Line	어스선(組)	1	
A-30	02-003A-2700	L-7, M-7	Nylon Clip	나일론 클립	3	
A-31*	01-035A-5060	L, L-7	Needle Plate (1/8")	침판(1/8"-3.2mm)	1	
A-32*	01-035A-5300	M, M-7	Needle Plate (1/8")	침판(1/8"-3.2mm)	1	
A-33	01-136S-1230		Screw For Needle Plate	침판 나사	2	
A-34	01-434A-1230		Slide Plate	미끄럼판(組)	1	
A-35	01-145A-5307		Sub Needle Plate	보조 침판	1	
A-36	01-136S-1230		Screw For Needle Plate	침판 나사	2	
A-37	01-035M-5060	L	Model Mark (KM-506)	모델 마크	1	
A-38	01-016M-5300	M	Model Mark (KM-530)	모델 마크	1	
A-39	01-035M-506S	L-7	Model Mark (KM-506-7S)	모델 마크	1	
A-40	01-040M-537S	M-7	Model Mark(KM-530-7S)	모델 마크	1	
A-41	01-035P-1370		Number Plate	번호판	1	
A-42	01-035P-7400		Pin	번호판 핀	2	
A-43	01-038M-2500		Brand Mark	면판 마크	1	
A-44	01-116A-2350		Guide Bar	실안내봉	1	
A-46	40-201A-2700	L-7, M-7	Supplementary Tension Control Ass'y	보조 사조자	1조	
A-47	SC-0104-5607	L-7, M-7	Screw (11/64" n=40)	하측 중베어링 붓싱고정나사(11/64" n=40)	1	
A-48	01-027A-1230	L, M	Three Hole Thread Guide Ass'y	세구멍 실결이(組)	1	A-48 Ass'y
A-48-1	01-015A-1230	L, M	Three Hole Thread Guide	세구멍 실결이	1	
A-48-2	01-027C-1230	L, M	Nut For A-48-1	세구멍 실결이 너트	2	
A-50	01-030C-1230		Arm Thread Guide	암 실결이	1	
A-51	SC-0120-1230		Screw (9/64" n=40)	오일 펌프 카바나사(9/64" n=40)	1	
A-52	01-031C-1230		Thread Guide For A-5	면판 실결이	1	
A-53	SC-0120-1230		Screw (9/64" n=40)	오일 펌프 카바나사(9/64" n=40)	1	
A-54	40-004A-350A		Thread Tension Control Ass'y	실조절 장치(組) A-Type	1조	
A-55	05-013C-257U		Arm Thread Guide(L)	암 실안내(L)	1	
A-57	SC-0114-1230		Screw (15/64" n=28)	실채기 힌지핀 나사(15/64" n=28)	1	
A-58	01-017C-1230	L, M	Bed Base "FRONT"(B)	베드 받침(후)	1	
A-59	01-047A-5300		Chip Shute Guide(U)	칩 배출 가이드(上)	1	
A-60	SC-0539-5050		Screw (9/64" n=40)	후 카바 고정나사(9/64" n=40)	2	
A-61	40-104A-3500		Cap For Tension Release Pin	실늦추기 핀 캡	1	

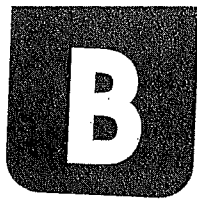

Upper Shaft & Thread Take Up Lever Mechanism

상축 및 실채기 관계

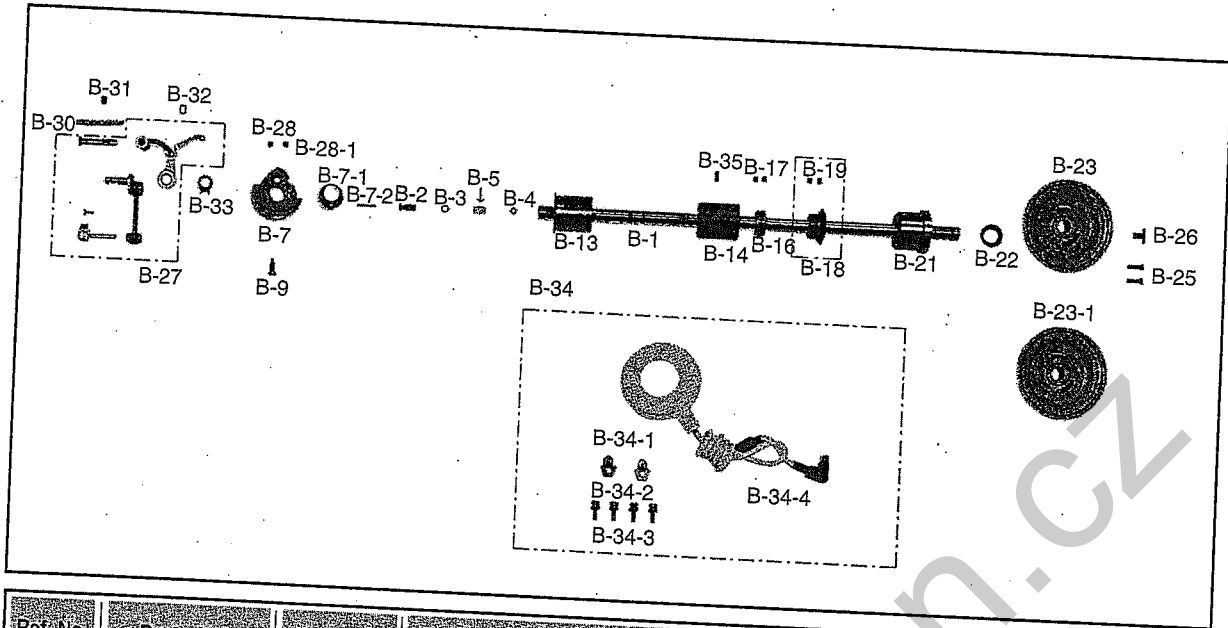

Ref. No.	Parts No.	Note	Name of Parts	품 명	Q ty	Assembly No.
B-1	02-101A-5300		Upper Shaft	상축(Servo) L=419.5	1	
B-2	02-115C-2500		Oil Adjusting Pin For B-1	상축 유량 조절핀	1	
B-3	02-016R-1230		O-Ring For B-2	상축 유량 조절핀 O링	1	
B-4	02-018W-1230		Rubber for B-2	상축 유량 조절 고무	1	
B-5	02-020M-1230		Upper Shaft Felter	상축 펠트	1	
B-7	02-110A-5300		Link Cam	링크 캠	1조	
B-7-1	02-111A-5300		Mes Cam	메스캠	1	
B-7-2	02-011P-5300		Pin For B-7-1	메스캠 부착 기준핀	1	
B-9	SC-0123-1230		Screw (9/32" n=28)	링크캠 위치 고정나사(9/32" n=28)	1	
B-13	02-115A-5300		Upper Shaft Bushing (F)	상축 전붓싱	1	
B-14	02-105A-2500		Upper Shaft Bushing (M)	상축 중붓싱	1	
B-16	02-121A-1230		Upper Shaft Collar	상축 카라	1	
B-17	SC-A129-4515		Screw (1/4" n=40)	홈볼이 멈춤나사(1/4" n=40)	2	
B-18	02-211A-1230		Upper Shaft Gear	상축 기어	1	
B-19	SC-A129-4515		Screw (1/4" n=40)	홈볼이 멈춤나사(1/4" n=40)	2	
B-21	02-106A-257B		Upper Shaft Bushing(R)	상축 후붓싱	1	
B-22	02-028C-1230		Oil Seal For B-20, 21	상축 오일셀	1	
B-23	02-207A-257A		Pulley (Only for Trimming M/C)	폴리	1	
B-23-1	02-207A-257A		Pulley (Only for Regulator M/C)	폴리	1	
B-25	SC-0150-2500	L, M, L-7	Screw (15/64" n=28)	폴리 고정나사(15/64" n=28)	2	
B-26	SC-0188-1230	L, M	Screw(5/16" n=24)	폴리 큰나사(5/16" n=24)	1	
B-27	08-201A-250A		Thread Take Up Lever Ass'y	실채기(조) 110-39070	1	
B-28	SC-0504-1230		Screw (1/4" n=40)	실채기핀 고정나사(1/4" n=40)	1	
B-28-1	SC-0129-7400		Screw (1/4" n=40)	기어나사(1/4" n=40)	1	
B-30	44-0000-1230		Oil Wick	오일심지	1	
B-31	SC-0507-1230		Screw (15/64" n=28)	상축붓싱 고정나사(15/64" n=28)	1	
B-32	08-005R-250A		Oil Protection Rubber	오일막이 고무	1	
B-33	08-106C-2500		Protection Plate	링크캠 접촉판	1	
B-34			Synchronizer Ass'y	싱크로나이저(조)	1	
B-34-1	11-020A-2500		Magnetic Holder	마그네틱 홀더	(2)	B-34
B-34-2	11-022W-2500		Washer For B-34-1	마그네틱 홀더 림와셔	(4)	
B-34-3	11-021S-2500		Screw For B-34-1	마그네틱 홀더 림나사	(4)	
B-34-4	13-0000-SE55		Synchronizer Ass'y (Servo)	싱크로나이저(조)Servo	(1)	
B-35	SC-0507-1230		Screw (15/64" n=28)	상축붓싱 고정나사(15/64" n=28)	1	

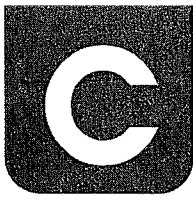

Upright Shaft & Lower Shaft Mechanism

세운축 및 하축 관계

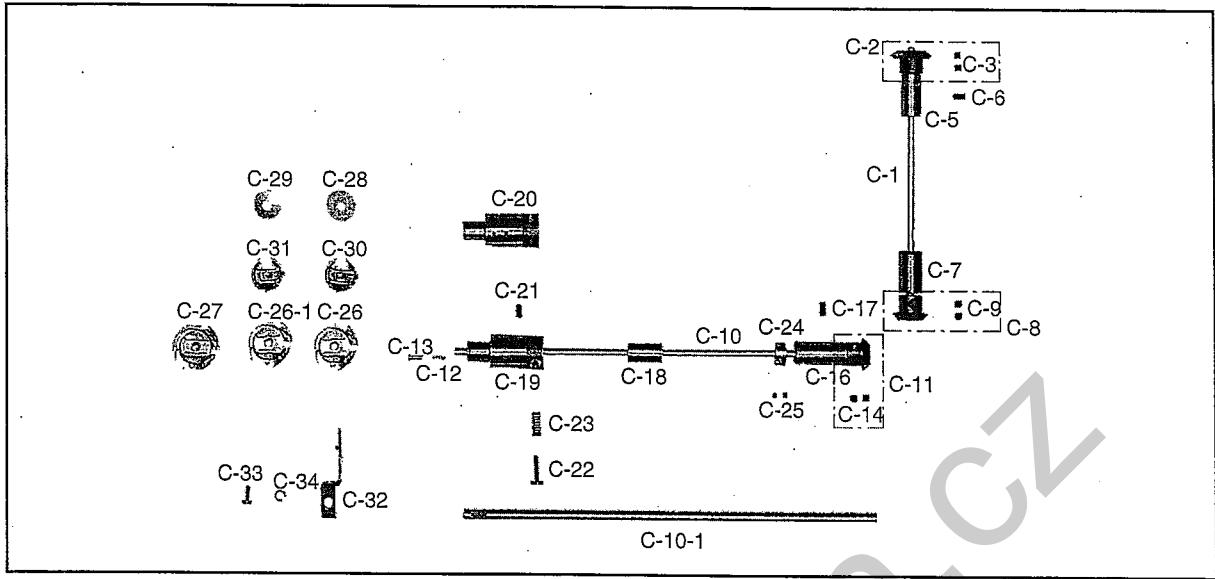

Ref. No.	Parts No.	Note	Name of Parts	품 명	Q-ty	Assembly No
C-1	03-001A-1600		Upright Shaft	입축	1	
C-2	02-112A-1230		Upright Shaft Gear(U)	입축 상기어	1	
C-3	SC-A129-4515		Screw(1/4" n=40)	홈볼이 멈춤나사(1/4" n=40)	2	
C-4	03-002A-257A	L-7, M-7	Upright Shaft Bushing(U)	입축 상붓싱	1	
C-5	03-102A-1230	L, M	Upright Shaft Bushing(U)	입축 상붓싱	1	
C-6	SC-0507-4515		Screw (15/64" n=28)	홈볼이 멈춤나사(15/64" n=28)	1	
C-7	03-103A-1230		Upper Shaft Lower B/S	입축 하붓싱	1	
C-8	02-113A-1230		Upright Shaft Gear(L)	입축 하기어	1	
C-9	SC-A129-4515		Screw (1/4" n=40)	홈볼이 멈춤나사(1/4" n=40)	2	
C-10	07-103A-257A	L-7, M-7	Lower Shaft	하축	1	
C-10-1	07-103A-2500	L, M	Lower Shaft	하축	1	
C-11	02-114A-1230		Lower Shaft Gear	하축 기어	1	
C-12	07-005M-1230		Lower Shaft Felter	하축 펠트	1	
C-13	07-004S-1230		Cap Screw For Lower Shaft Oil	하축 펠트 꽃이 나사	1	
C-14	SC-A129-4515		Screw (1/4" n=40)	홈볼이 멈춤나사(1/4" n=40)	2	
C-16	07-102A-1600		Lower Shaft Bushing(R)	하축 뒷붓싱	1	
C-17	SC-0507-1230		Screw (15/64" n=28)	상축 붓싱 고정나사(15/64" n=28)	1	
C-18	07-103A-1600		Lower Shaft Bushing(M)	하축 중붓싱(7.94×20×25)	1	
C-19	07-007A-257A	L-7, M-7	Lower Shaft Bushing(F)	하축 전붓싱(PBB才質)	1	
C-20	07-107A-250A	L, M	Lower Shaft Bushing(F)	하축 전붓싱	1	
C-21	SC-0114-1230		Screw (15/64" n=28)	실채기 힌지핀 고정나사(15/64" n=28)	1	
C-22	SC-0361-1230		Screw (3/16" n=32)	하축 오일 조절나사(3/16" n=32)	1	
C-23	07-015G-1230		Spring For C-22	하축 오일 조절나사 스프링	1	
C-24	44-025A-1230		Collar For Lower Shaft	오일 펌프 카라 (B) 7.94×17×8	1	
C-25	SC-0104-5607		Screw (11/64" n=40)	하축 중베어링 붓싱 고정나사(11/64" n=40)	1	
C-26	07-003A-270A	L-7	Rotary Hook Ass'y	가마(HSH-7.94B)	1조	
C-26-1	07-001A-357A	M, M-7	Rotary Hook Ass'y	가마(HSH-7, 94BTRN)	1조	
C-27	07-007A-123A	L	Rotary Hook Ass'y	가마	1	
C-28	07-105A-2700	L-7, M-7	Bobbin(AL)	보빈	1	
C-29	07-105A-2700	L, M	Bobbin(Steel)	보빈	1	
C-30	07-104A-2700	L-7	Bobbin Case Ass'y	보빈 케이스(BC-DBI-NBL)	1조	
C-30	07-004A-3500	M, M-7	Bobbin Case Ass'y	보빈 케이스(침송형) BC-DLN-N	1조	
C-31	07-106A-123A	L	Bobbin Case Ass'y	보빈 케이스(BC-DBI)	1조	
C-32	07-013A-1230		Inner Bobbin Stopper	가마 잡이	1	
C-33	SC-0174-1230		Screw (11/64" n=40)	홈볼이 납작 작은나사(11/64" n=40)	1	
C-34	07-011W-1230		Washer For C-33	가마잡이 와셔	1	

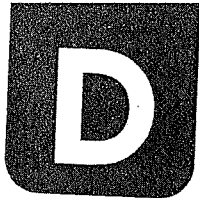

Feed Mechanism 피이드 관계

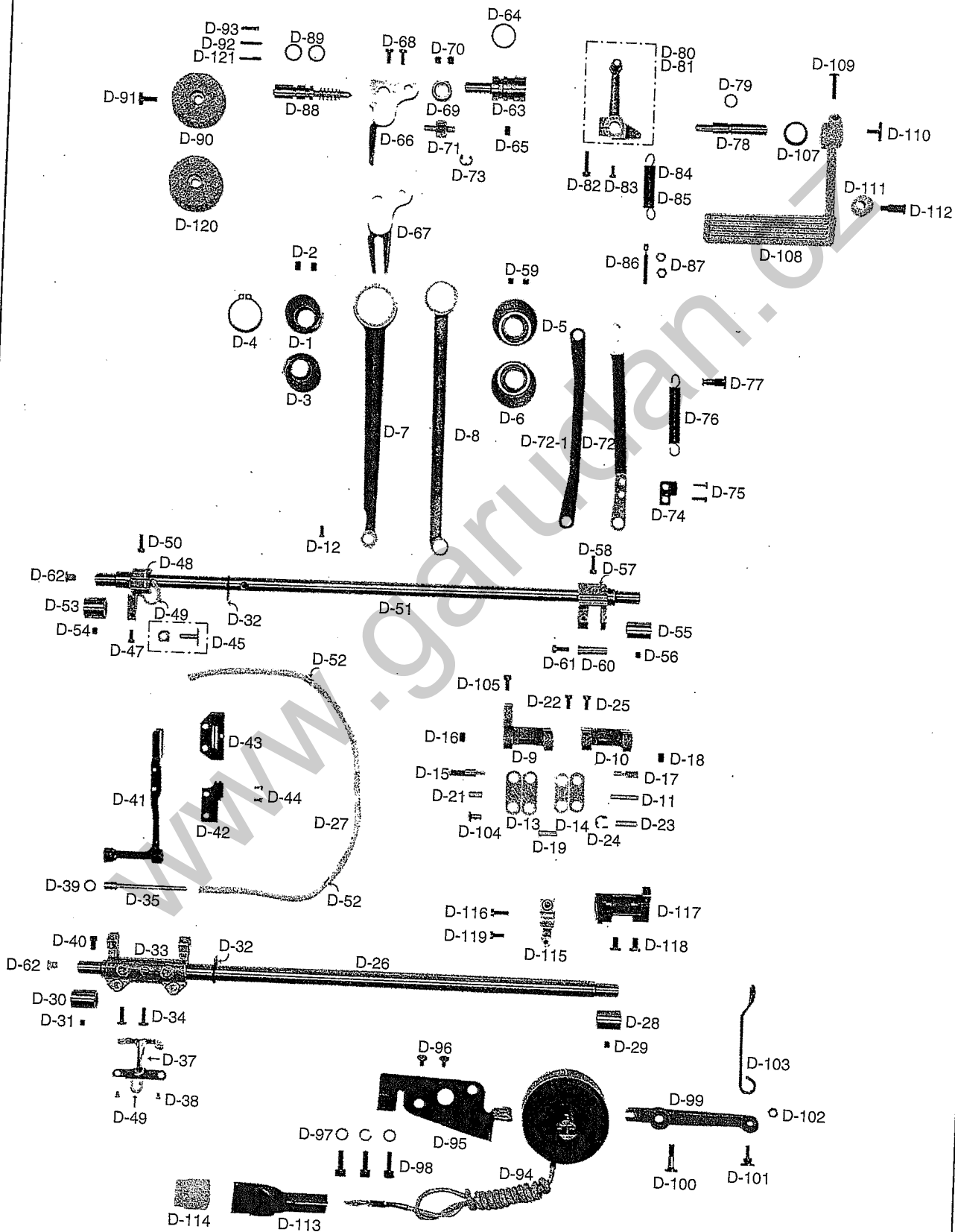

Ref. No.	Parts No.	Note	Name of Parts	품 명	Q'ty	Assembly No.
D-1	06-101A-250A	L, L-7	Feed Cam A	피이드 캠 A	1	
D-2	SC-0129-7400		Screw (1/4" n=40)	기어나사 (1/4" n=40)	2	
D-3	06-101A-350A	M, M-7	Feed Cam A	피이드 캠 A	1	
D-4	06-103C-235B		Stop Ring "C" For D-1, 3	스냅링 (φ 28)	1	
D-5	06-102A-2500	L, L-7	Feed Cam C	피이드 캠 C	1	
D-6	06-102A-3500	M, M-7	Feed Cam C	피이드 캠 C	1	
D-7	06-103A-2500		Feed Rocker Shaft Connecting Rod	수평이송 로드	1	
D-8	06-154A-1230		Crank Rod	크랭크 로드	1	
D-9	06-004A-257A	L-7, M-7	Feed Regulator Link	피이드 조절링크	1	
D-10	06-103A-2350	L, M	Feed Regulator Link	피이드 조절링크	1	
D-11	06-104P-2350		Feed Connection Link Pin(A)	피이드 연결 링크 핀(A)	1	
D-12	SC-0496-3710		Screw (11/64" n=40)	하측 뒷부싱 고정나사(11/64" n=40)	1	
D-13	06-105A-2350		Feed Connection Link(A)	피이드 연결링크(A)	2	
D-14	06-106A-2350		Feed Connection Link(B)	피이드 연결링크(B)	2	
D-15	06-107P-2350		Feed Adjusting Link hinge Pin(A)	피이드 조절링크 힌지핀(A)	1	
D-16	SC-0504-1230		Screw (1/4" n=40)	실채기핀 고정나사(1/4" n=40)	1	
D-17	06-108P-2350		Feed Adjusting Link Hinge Pin(B)	피이드 조절링크 힌지핀(B)	1	
D-18	SC-0504-1230		Screw (1/4" n=40)	실채기 핀 고정나사(1/4" n=40)	1	
D-19	06-109P-2350		Feed Connection Link pin(B)	피이드 연결링크 핀(B)	1	
D-21	06-110P-2350		Feed Connection Link Pin(C)	피이드 연결링크 핀(C)	1	
D-22	SC-0175-1230		Screw (11/64" n=40)	실채기 카바 고정나사(11/64" n=40)	1	
D-23	06-023P-2350		Hinge Pin for D-72	피이드 조절 연결로드 힌지핀	1	
D-24	04-009C-3710		E-Ring (φ 5)	E링 (φ 5)	1	
D-25	SC-0175-1230		Screw (11/64" n=40)	실채기 카바 고정나사(11/64" n=40)	1	
D-26	06-112A-2350		Feed Rock Shaft	수평밀대	1	
D-27	44-0000-1230		Wick For D-26, 51	유심	1	
D-28	06-140A-1230		Feed Rock Shaft Bushing(R)	들대 부싱(후) 11.11×16.8×20	1	
D-29	SC-0114-1230		Screw (15/64" n=28)	실채기 힌지핀 나사(15/64" n=28)	1	
D-30	06-113A-2350		Feed Rock Shaft Bushing(F)	수평밀대 전부싱 11.11×17.74×16	1	
D-31	SC-0114-1230		Screw (15/64" n=28)	실채기 힌지핀 고정나사(15/64" n=28)	1	
D-32	06-021R-1230		Oil cover For D-26, 51	들밀대 고무마개	2	
D-33	06-008A-2350		Feed Bar Crank	뜸니 받침 크랭크	1	
D-34	SC-0307-1230		Screw (3/16" n=32)	뜸니 받침 크랭크 캠나사(3/16" n=32)	2	
D-35	06-114A-2350		Feed Bar Shaft	뜸니 받침 축	1	
D-37	44-009C-1230		Wick Holder For D-35	심지 지지대	1	
D-38	SC-0133-1230		Screw (1/8" n=44)	심지 지지대나사(1/8" n=44)	2	
D-39	06-002W-2350		Washer For D-35	뜸니 받침 축 와셔	1	
D-40	SC-0122-1230		Screw (15/64" n=28)	뜸니 받침 축 고정나사(15/64" n=28)	1	
D-41	06-215A-2350		Feed Bar	뜸니 받침	1	
D-42*	06-107A-5060	L, L-7	Feed Dog 1/8"	뜸니(1/8", 5/32", 3/16")	1	
D-43*	06-138A-5300	M, M-7	Feed Dog 1/8"	뜸니(1/8", 5/32", 3/16")	1	
D-44	SC-0130-1230		Screw (1/8" n=44)	뜸니 캠나사(1/8" n=44)	2	
D-45	06-117A-1230		Feed Bar Block And Shaft	뜸니 받침 블럭	1	
D-47	06-020S-1230		Screw (3/16" n=32)	홈볼이 냄비 작은나사(3/16" n=32)	1	
D-48	06-128A-2350		Feed Lifting Shaft Crank(F)	들대 크랭크(前)	1	
D-49	44-0000-1230		Oil Wick	오일심지	1	
D-50	SC-0497-1230		Screw (3/16" n=28)	들대 크랭크(전) 고정나사(3/16" n=28)	1	
D-51	06-116A-2350		Feed Lifting Shaft	들대	1	
D-52	44-029M-1230		Stopper For Wick	오일 심지 스톱퍼	2	
D-53	06-139A-1230		Feed Lifting Shaft Bushing(F)	들대 부싱(전) 11.11×17.46×20	1	
D-54	SC-0114-4515		Screw (15/64" n=28)	홈볼이 멈춤나사(15/64" n=28)	1	
D-55	06-140A-1230		Feed Lifting Shaft Bushing(R)	들대 부싱(후) 11.11×16.8×20	1	
D-56	SC-0114-1230		Screw (15/64" n=28)	실채기 힌지핀 고정나사(15/64" n=28)	1	
D-57	06-038A-235A		Feed Lifting Shaft Crank(R)	들대 크랭크(後)	1	
D-58	SC-0497-1230		Screw (3/16" n=28)	들대 크랭크(전) 고정나사(3/16" n=28)	1	
D-59	SC-0504-1230		Screw (1/4" n=40)	실채기핀 고정나사(1/4" n=40)	2	
D-60	06-037P-1230		Crank Rod Connection Pin	들밀대 크랭크 핀	1	
D-61	SC-0175-1230		Screw (11/64" n=40)	실채기 카바나사(11/64" n=40)	1	
D-62	01-037R-1230		Rubber Cap (F) For D-26, 51	들밀대 유심마개	2	

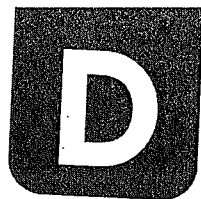

Feed Mechanism 피이드 관계

10

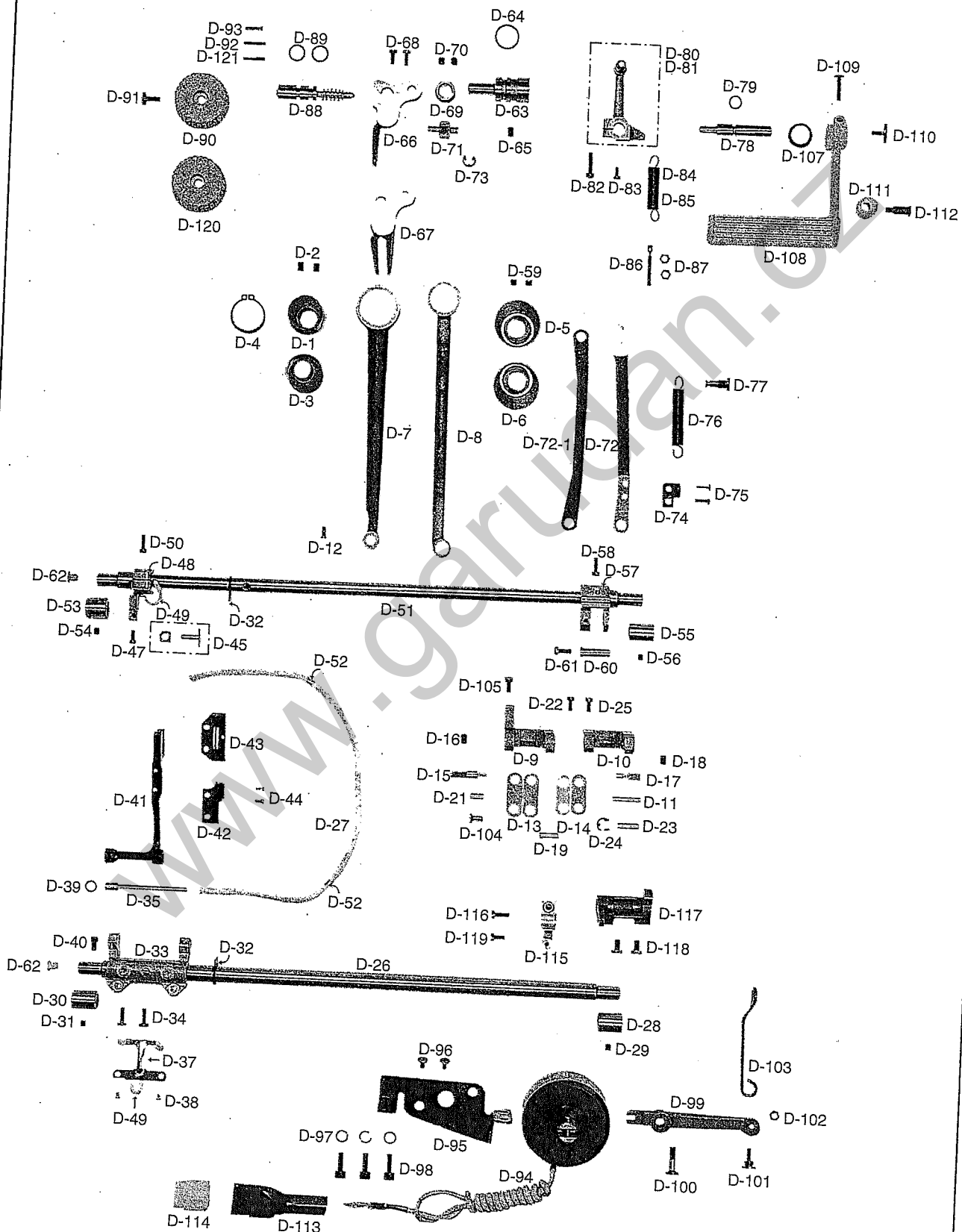

Ref. No.	Parts No.	Note	Name of Parts	품 명	Q'ty	Assembly No.
D-63	06-118A-2350		Feed Regulator Shaft	피이드 조절기 축	1	
D-64	06-043R-1230		O-Ring For D-63	피이드 조절기 붓싱 오링	2	
D-65	SC-0507-1230		Screw (15/64" n=28)	상축 붓싱 고정나사(15/64" n=28)	1	
D-66	06-119A-2350	L-7, M-7	Feed Regulator	피이드 조절기(사절용)	1	
D-67	06-119A-1370	L, M	Feed Regulator	피이드 조절기(비사절용)	1	
D-68	SC-0174-1230		Screw (11/64" n=40)	가마잡이 나사(11/64" n=40)	2	
D-69	06-220A-2350		Collar For D-63	피이드 조절기 축 카라	1	
D-70	SC-0129-7400		Screw (1/4" n=40)	기어나사(1/4" n=40)	2	
D-71	06-221A-2350		Feed Adjusting Shaft	피이드 조절 축	1	
D-72	06-122A-2500	L-7, M-7	Connecting Rod For Feed Regulator	피이드 조절 로드	1	
D-72-1	06-122A-1370	L, M	Connecting Rod For Feed Regulator	피이드 조절기 로드	1	
D-73	04-009C-3710		E-Ring(φ 5)	E링 (φ 5)	1	
D-74	06-023C-257A	L-7, M-7	B/T Spring Holder	자동 역진 스프링 홀더	1	
D-75	SC-0158-3710	L-7, M-7	Screw (9/64" n=40)	면판캡나사(9/64" n=40)	1	
D-76	06-023G-7400	L-7, M-7	Reverse Feed Spring	역진 레버 스프링	1	
D-77	06-024C-257A	L-7, M-7	Holder For D-76	자동 역진 스프링 걸이	1	
D-78	06-125A-2500		Reverse Feed Control Lever Shaft	역진 레버축	1	
D-79	06-042R-1230		O-Ring For D-78	레버축 오링	1	
D-80	06-026A-257A	L-7, M-7	Reverse Feed Lever Crank (Ass'y)	역진 레버 인장 크랭크(조)	1	
D-81	06-026A-250A	L, M	Reverse Feed Lever Crank (Ass'y)	역진 레버 인장 크랭크(조)	1	
D-82	SC-0184-1600		Screw (3/16" n=28)	수평밀대 크랭크 캡나사(3/16" n=28)	1	
D-83	SC-0174-1230		Screw (11/64" n=40)	가마잡이 나사(11/64" n=40)	1	
D-84	06-023G-7400	L-7, M-7	Spring For D-109	역진 레버 스프링	1	
D-85	06-056G-2350	L, M	Spring For D-109	역진 레버 스프링	1	
D-86	06-040S-1600	L-7, M-7	Holder For D-84, 85	스프링걸이 축 나사	1	
D-87	SN-0101-1600	L-7, M-7	Nut (11/64" n=40)	스프링걸이 축 나사너트(11/64" n=40)	2	
D-88	06-027A-2500		Feed Regulator Dial Shaft	피이드 조절 다이알 축	1	
D-89	06-010R-1230		O-Ring For D-88	다이알 축 오링	2	
D-90	06-028C-350B	L, M	Feed Regulator Control Plate (5mm)	다이알 문자판(5mm)	1	
D-91	SC-0193-1230		Screw (3/16" n=28)	다이알판 고정나사(3/16" n=28)	1	
D-92	06-026P-1230		Pin for D-90	다이알 핀	1	
D-93	06-027G-1230		Spring for D-92	다이알 스프링	1	
D-94	06-048A-2507	L-7, M-7	Reverse Feed Solenoid Ass'y	역진 솔레노이드(SBT-5)	1조	
D-95	06-130A-257A	L-7, M-7	Bracket For Reverse Feed Solenoid	역진 솔레노이드 브라켓	1	
D-96	SC-0166-2350	L-7, M-7	Screw (M5×0.8)	역진 솔레노이드 부착나사(M5×0.8)	2	
D-97	01-020W-2350	L-7, M-7	Spring Washer For D-95	상크로 베이스 스프링 와셔(φ6)	3	
D-98	SC-0109-2350	L-7, M-7	Screw (M6)	역진 솔레노이드 브라켓 캡나사(M6)	3	
D-99	06-131A-257A	L-7, M-7	Reverse Feed Solenoid Crank	역진 솔레노이드 크랭크	1	
D-100	06-032S-257A	L-7, M-7	Stud Screw For D-99	역진 솔레노이드 크랭크 단나사	1	
D-101	06-033S-257A	L-7, M-7	Hinge Screw For D-103	역진 솔레노이드 연결로드 힌지나사	1	
D-102	40-005C-2700	L-7, M-7	Hinge Nut For D-103	케이블 연결너트(B)	1	
D-103	06-034A-257A	L-7, M-7	Reverse Solenoid Connecting Rod	역진 솔레노이드 연결로드	1	
D-104	06-035A-257A	L-7, M-7	Hinge Pin For D-103	역진 솔레노이드 연결로드 힌지핀	1	
D-105	SC-0175-1230	L-7, M-7	Screw (11/64" n=40)	실채기 카바나사(11/64" n=40)	1	
D-107	06-053W-1230		Washer For D-77	레버 와셔	1	
D-108	06-036C-2500		Feed Regulator Lever	역진 레버	1	
D-109	SC-0186-1230		Screw (3/16" n=32)	역진 레버 고정나사(3/16" n=32)	1	
D-110	SC-0185-1230		Screw (3/16" n=32)	레버 덮개 나사(3/16" n=32)	1	
D-111	06-072R-7507	L-7, M-7	Stopper Rubber For D-108	역진 레버 스톱퍼 (상) 고무	1	
D-112	06-017S-7507	L-7, M-7	Stopper Stud Screw For D-108	역진 레버 스톱퍼 (상) 단나사	1	
D-113	11-019M-2350	L-7, M-7	Terminal Tube(L)	솔레노이드 튜브	1	
D-114	11-018M-2350	L-7, M-7	Solenoid Terminal(12P)	솔레노이드 프리그	1	
D-115	06-311A-2350	L, L-7	Lever Feed Crank(R)	수평밀대 크랭크(後)	1	
D-116	SC-0497-1230	L, L-7	Screw (3/16" n=28)	들레 크랭크(전) 고정나사(3/16" n=28)	2	
D-117	06-129A-3500	M, M-7	Lever Feed Crank(R)	수평밀대 크랭크	1	
D-118	SC-0327-3500	M, M-7	Screw (9/32" n=28)	수평밀대 크랭크(후)캡나사(9/32" n=28)	2	
D-119	SC-0496-3716		Screw (11/64" n=40)	홈볼이 납작 작은나사(11/64" n=40)	1	
D-120	06-028C-357B	L-7, M-7	Feed Regulator Control Plate(5mm)INSERT	다이알 문자판(5mm)	1	
D-121	06-027P-2350	L-7, M-7	Dial Pin	다이알 핀	1	

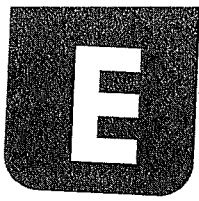

Thread Trimmer Mechanism 사절 관계

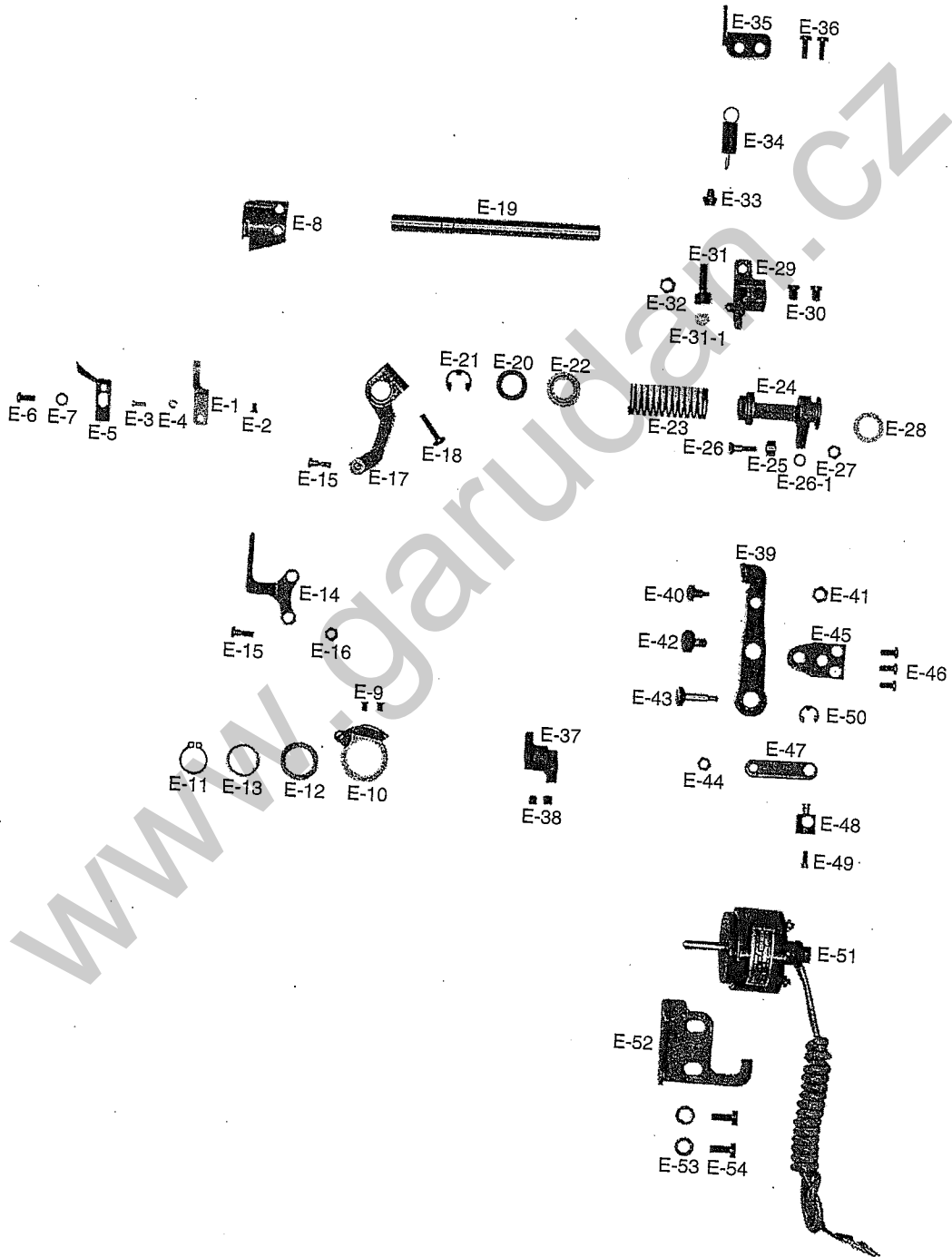

Ref. No.	Parts No.	Note	Name of Parts	품 명	Q'ty	Assembly No.
E-2	10-101A-2700	L-7, M-7	Fixed Mes	고정 메스(7AN701)	1	
E-3	SC-A301-4119	L-7, M-7	Screw (9/64" n=40)	홈이 접시 작은나사(9/64" n=40)	1	
E-4	SC-0137-2700	L-7, M-7	Screw (1/8" n=40)	고정메스 장력 조절나사(1/8" n=40)	1	
E-5	SN-0103-2700	L-7, M-7	Nut (1/8" n=40)	고정메스 장력 조절나사 너트(1/8" n=40)	1	
E-6	10-005A-2700	L-7, M-7	Thread Retaining Plate	실가리개	1	
E-7	SC-0543-2302	L-7, M-7	Screw (11/64" n=40)	톱 카바 힌지 고정나사(11/64" n=40)	1	
E-8	01-017W-1600	L-7, M-7	Washer For E-6	뿔뚜껑 씌와셔	1	
E-9	10-106A-2700	L-7, M-7	Rotary Mes	회전메스(7AN414)	1	
E-10	SC-A154-4114	L-7, M-7	Screw (11/64" n=40)	접시머리 보울트(11/64" n=40)	2	
E-11	10-108A-257A	L-7, M-7	Thread Trimming Holder	사절홀더	1	
E-12	10-009C-2700	L-7, M-7	Stop Ring For E-11	스냅링 (φ 15)	1	
E-13	10-110W-2700	L-7, M-7	Washer For E-11	사절 홀더 와셔	1	
E-14	10-011A-2700	L-7, M-7	Needle Bearing	니이들 베어링	1	
E-15	10-015A-5307	L-7, M-7	Thread Trimming Lever Connecting Link	사절레버 연결링크	1	
E-16	10-013S-257A	L-7, M-7	Stud Screw For E-15	사절레버 연결링크 단나사	2	
E-17	SN-0101-1600	L-7, M-7	Nut (11/64" n=40)	육각너트(11/64" n=40)	1	
E-18	10-114A-257A	L-7, M-7	Thread Trimming Lever	사절 레버	1	
E-19	SC-0108-4113	L-7, M-7	Screw (M6)	육각구멍볼이 보울트(M6)	1	
E-20	10-115A-257A	L-7, M-7	Thread Trimming Shaft	사절축	1	
E-21	10-116W-257A	L-7, M-7	Thread Trimming Shaft Washer	사절축 와셔	1	
E-22	43-009C-1600	L-7, M-7	E-Ring (φ 9)	제어체 축링(E링 9)	1	
E-23	10-017A-257A	L-7, M-7	Return Spring Guide Bushing	리턴 스프링 가이드 bushes	1	
E-24	10-018G-257A	L-7, M-7	Slide Arm Return Spring	슬라이드 아암 리턴 스프링	1	
E-25	10-119A-257A	L-7, M-7	Slide Arm	슬라이드 아암	1	
E-26	10-066A-7507	L-7, M-7	Roller	로울러	1	
E-27	10-067S-7507	L-7, M-7	Stud Screw For E-26	로울러 단나사	1	
E-27-1	07-011W-1230	L-7, M-7	Washer	와셔	1	
E-28	SN-0115-7400	L-7, M-7	Nut (3/16" n=32)	육각너트(3/16" n=32)	1	
E-29	10-044R-5607	L-7, M-7	Cushion Washer For E-20	쿠션 고무(B)	2	
E-30	10-121A-257A	L-7, M-7	Cam Follower Crank	사절캠 증동 크랭크	1	
E-31	15-002S-5607	L-7, M-7	Screw For E-30	노루발 상하운동 캠 고정나사	2	
E-32	10-032S-257A	L-7, M-7	Stopper Screw	스토퍼 쿠션 나사	1	
E-32-1	10-032R-257A	L-7, M-7	Cushion Rubber for E-32	스토퍼 쿠션 고무	1	
E-33	SN-0105-3400	L-7, M-7	Nut (15/64" n=28)	육각너트(15/64" n=28)	1	
E-34	10-122P-257A	L-7, M-7	Stopper Pin	스토퍼 핀(베드 部)	1	
E-35	10-023G-257A	L-7, M-7	Spring For E-30	사절캠 증동 크랭크 스프링	1	
E-36	10-124C-257A	L-7, M-7	Spring Holder	스프링 걸이	1	
E-37	SC-0548-7400	L-7, M-7	Screw (3/16" n=28)	홈이 납작 작은나사(3/16" n=28)	2	
E-38	10-125A-257A	L-7, M-7	Thread Trimming Cam	사절캠	1	
E-39	SC-A308-4517	L-7, M-7	Screw (1/4" n=40)	육각구멍볼이 멈춤나사(1/4" n=40)	2	
E-40	10-126A-257A	L-7, M-7	Clutch Lever	클러치 레버	1조	
E-41	10-027S-257A	L-7, M-7	Stud Screw For E-40	클러치 레버 작동핀 나사	1	
E-42	SN-0105-3400	L-7, M-7	Nut (15/64" n=28)	육각너트(15/64" n=28)	1	
E-43	43-004S-3400	L-7, M-7	Clutch Lever Moving Pin Screw	무릎 올림봉 단나사	1	
E-44	10-028S-257A	L-7, M-7	Stud Screw For E-48	솔레노이드 연결링크 단나사	1	
E-45	SN-0115-7400	L-7, M-7	Nut (3/16" n=32)	육각너트(3/16" n=32)	1	
E-46	10-029A-257A	L-7, M-7	Base Plate	베이스 플레이트	1	
E-47	SC-0548-7400	L-7, M-7	Screw (3/16" n=28)	홈이 납작 작은나사(3/16" n=28)	3	
E-48	10-130A-257A	L-7, M-7	Solenoid Connection Link	솔레노이드 연결링크	1	
E-49	10-031P-257A	L-7, M-7	Solenoid Pin	솔레노이드 핀	1	
E-50	SC-0496-3710	L-7, M-7	Screw (11/64" n=40)	홈이 납작 작은나사(11/64" n=40)	1	
E-51	04-009C-3710	L-7, M-7	E-Ring (φ 5)	E링 (φ 5)	1	
E-52	10-044A-2507	L-7, M-7	Thread Trimming Solenoid Ass'y	사절 솔레노이드 (STT-5)	1조	
E-53	10-033A-257A	L-7, M-7	Base For E-52	사절 솔레노이드 베이스	1	
E-54	01-020W-2350	L-7, M-7	Washer For E-52	싱크로베이스 스프링 와셔(φ 6)	2	
E-55	SC-0183-2700	L-7, M-7	Screw (15/64" n=28)	홈이 납작 작은나사(15/64" n=28)	2	

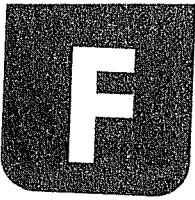

Mes Driving Mechanism

메스 구동 관계

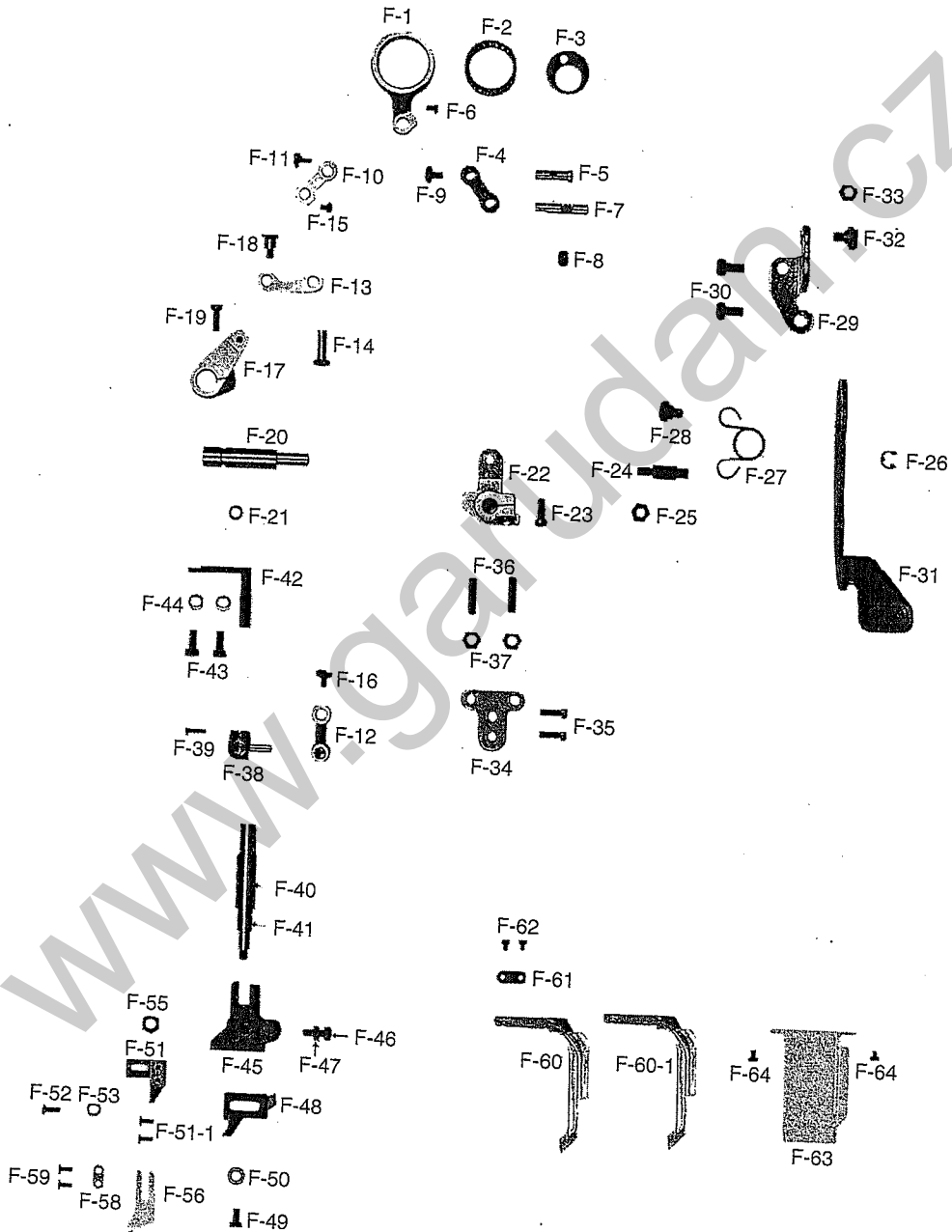

Ref. No.	Parts No.	Note	Name of Parts	품명	Qty	Assembly No.
F-1	13-101A-5300		Mes Driving Rod	메스 구동 로드	1	
F-2	55-042A-5050		Needle Bearing	니들 베어링	1	
F-3	13-003A-5300		Needle Bearing Cover	니들 베어링 커버	1	
F-4	13-104A-5300		Mes Driving Rod Link	메스 구동 로드 링크	1	
F-5	13-005P-5300		Link Pin For F-4	메스 구동 로드 링크 핀	1	
F-6	SC-0502-2302		Screw (9/64" n=40)	빛뚜껑 고정판 고정나사(대)(9/64" n=40)	1	
F-7	13-007A-5300		Shaft For F-4	메스 구동 로드 링크 축	1	
F-8	SC-0507-1230		Screw (15/64" n=28)	상축 볼싱 고정나사(15/64" n=28)	1	
F-9	SC-0525-5300		Screw (11/64" n=40)	메스 구동 링크 축 캠나사(11/64" n=40)	1	
F-10	13-110A-5300		Mes Driving Link "A"	메스 구동 링크 "A"	1	
F-11	SC-0525-5300		Screw (11/64" n=40)	메스 구동 링크 축 캠나사(11/64" n=40)	1	
F-12	13-112A-5300		Mes Driving Link "B"	메스 구동 링크 "B"	1	
F-13	13-113A-5300		Mes Driving Link "C"	메스 구동 링크 "C"	1	
F-14	13-005P-5300		Mes Driving Link Pin	메스 구동 로드 링크 핀	1	
F-15	SC-0531-2302		Screw (9/64" n=40)	톱 카바 고정판 고정나사(소)(9/64" n=40)	1	
F-16	SC-0525-5300		Screw (11/64" n=40)	메스 구동 링크 축 캠나사(11/64" n=40)	1	
F-17	13-017A-5300		Link Support Arm	링크 지지암	1	
F-18	13-018S-5300		Hinge Screw For F-17	링크 지지암 힌지나사	1	
F-19	SC-0497-1230		Screw (3/16" n=28)	들대 크랭크(전) 고정나사(3/16" n=28)	1	
F-20	13-020A-5300		Mes Lever Shaft	메스 레버축	1	
F-21	13-021R-5300		O-Ring for F-20	메스 레버축 오링(φ5)	1	
F-22	13-022A-5300		Mes Lever Base	메스 레버 베이스	1	
F-23	SC-0497-1230		Screw (3/16" n=28)	들대 크랭크(전) 고정나사(3/16" n=28)	1	
F-24	13-024A-5300		Mes Lever Pin	메스 레버 핀	1	
F-25	13-025A-5300		Nut For F-24	메스 레버 핀 너트	1	
F-26	04-009C-3710		E-Ring (φ 5)	E링(φ 5)	1	
F-27	13-027A-5300		Mes Lever Return Spring	메스 레버 리턴 스프링	1	
F-28	13-028S-5300		Stud Screw For F-27	메스 레버 리턴 스프링 단나사	1	
F-29	13-029A-5300		Mes Lever Base Plate	메스 레버 고정판	1	
F-30	SC-0183-2700		Screw (15/64" n=28)	베이스 고정나사(B)(15/64" n=28)	2	
F-31	13-031A-5300		Mes Driving Lever	메스 작동 레버	1	
F-32	13-032S-5300		Stud Screw For F-31	메스 작동 레버 단나사	1	
F-33	43-005C-7500		Nut for F-32	누름대 올리기 레버지지 너트	1	
F-34	13-034A-5300		Stopper For F-31	메스 작동 레버 스톱퍼	1	
F-35	SC-0548-7400		Screw (3/16" n=28)	다이알 판 쥘나사(3/16" n=28)	2	
F-36	SC-0355-5300		Screw (15/64" n=28)	홈볼이 멈춤나사(15/64" n=28)	2	
F-37	13-025A-5300		Nut For F-36	메스 레버핀 너트	2	
F-38	13-138A-5300		Mes Driving Holder	메스 구동 홀더	1	
F-39	SC-0158-3710		Screw (9/64" n=40)	면판 쥘나사(9/64" n=40)	1	
F-40	13-140A-5300		Mes Driving Shaft Bush	메스 구동축 볼싱	1	
F-41	13-041A-5300		Mes Driving Shaft	메스 구동축	1	
F-42	13-042A-5300		Mes Mounting Base Guide	메스 부착 베이스 가이드	1	
F-43	SC-0190-2700		Screw (3/16" n=32)	스톱퍼 쥘나사(3/16" n=32)	2	
F-44	10-020W-2700		Washer For F-42	스톱퍼 쥘와셔	2	
F-45	13-146A-5300		Mes Mounting Base	메스 부착 베이스	1	
F-46	SC-0190-2700		Screw (3/16" n=32)	스톱퍼 쥘나사(3/16" n=32)	1	
F-47	SN-0105-3400		Nut	메스 레버핀 너트	1	
F-48	13-147A-5300		Mes Position Adjusting Plate	메스 위치 조정판	1	
F-49	SC-0174-1230		Screw (11/64" n=40)	가마 잠이나사(11/64" n=40)	1	
F-50	15-007W-3800		Washer For F-48	상하운동 조절축 와셔	1	
F-51	13-048A-5300		Mes Mounting Plate	메스 부착판	1	
F-51-1	SC-0513-5050		Screw (1/8" n=44)	칼날 조절나사	2	
F-52	SC-0528-1230		Screw (9/64" n=40)	톱 카바나사(9/64" n=40)	1	
F-53	02-019W-1230		Washer For F-51	상축 헬트 와셔	1	
F-55	SN-0105-3400		Nut For F-45	메스 레버핀 너트	1	
F-56	04-210A-5300		Mes	메스(B4121-522-000)	1	
F-58	55-004W-5050		Washer For F-56, 57	칼날 고정 와셔	1	
F-59	SC-0312-5050		Screw (1/8" n=44)	칼날 부착나사(1/8" n=44)	2	
F-60	13-053A-5300	L-7, M-7	Hook Protecting Plate(1/4")	훅 보호판(1/4")	1	
F-60-1	13-151A-5300	L, M	Hook Protect Plate(1/4")	훅 보호판(1/4")	1	
F-61	13-052W-5300		Washer For F-60	훅 보호판 와셔	1	
F-62	01-052S-5300		Screw (1/8" n=44)	홈볼이 납작 작은나사(1/8" n=44)	2	
F-63	13-054A-5300		Chip Shute Guide(M)	칩 배출 가이드(中)	1	
F-64	SC-0531-2302		Screw (9/64" n=40)	톱 카바 고정판 고정나사(소)(11/64" n=40)	2	



Needle Bar & Needle Bar Driving Mechanism

바늘대 및 바늘대 요동 관계

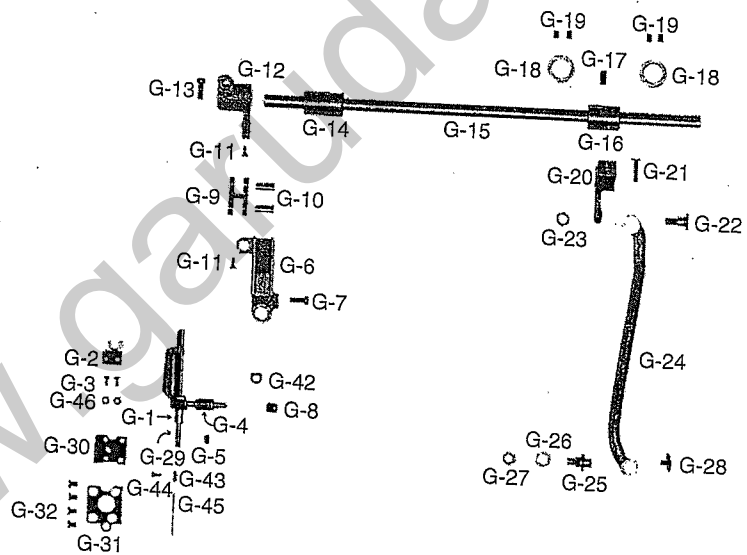
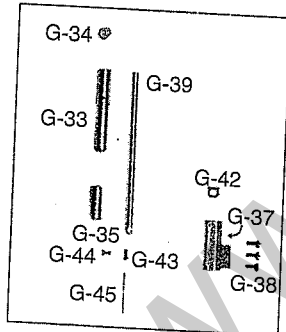

www.dan.cz

Ref. No.	Parts No.	Note	Name of Parts	품 명	Q. ty	Assembly No.
G-1	15-101A-3500	M, M-7	Needle Bar Frame	바늘대 후레임(110-03559)	1	
G-2	15-002A-3500	M, M-7	Needle Bar Frame Guide	바늘대 후레임 가이드	1	
G-3	SC-0157-1230	M, M-7	Screw (9/64" n=40)	노루발 쥘나사(9/64" n=40)	2	
G-4	15-103A-3500	M, M-7	Needle Bar Frame Shaft Bushing	바늘대 후레임축 붓싱	1	
G-5	SC-0352-7400	M, M-7	Screw (3/16" n=28)	가마축 붓싱 쥘나사(3/16" n=28)	1	
G-6	15-104A-3500	M, M-7	Slide Block Guide	슬라이드 블럭 가이드	1	
G-7	SC-0184-1600	M, M-7	Screw (3/16" n=28)	수평밀대 크랭크 쥘나사(3/16" n=28)	1	
G-8	15-105A-3500	M, M-7	Needle Bearing	니이들 베어링(B2913-412-N00)	1	
G-9	15-006A-3500	M, M-7	Driving Link	요동 링크	1	
G-10	15-007P-3500	M, M-7	Needle Bar Link Pin	바늘대 링크 핀	2	
G-11	SC-0159-3500	M, M-7	Screw (9/64" n=40)	바늘대 링크핀 고정나사(9/64" n=40)	2	
G-12	15-009A-3500	M, M-7	Driving Crank(F)	요동 크랭크(前)	1	
G-13	SC-0497-1230	M, M-7	Screw (3/16" n=28)	들레 크랭크(전) 고정나사(3/16" n=28)	1	
G-14	15-010A-3500	M, M-7	Rock Shaft Bushing(F)	요동축 붓싱(前)	1	
G-15	15-012A-3500	M, M-7	Needle Feed Connection Shaft	침송 연결축	1	
G-16	15-013A-3500	M, M-7	Rock Shaft Bushing(R)	요동축 붓싱(後)	1	
G-17	SC-0352-7400	M, M-7	Screw (3/16" n=28)	가마축 붓싱 쥘나사(3/16" n=28)	1	
G-18	15-011A-3500	M, M-7	Collar For G-15	침송 연결축 카라	2	
G-19	SC-0114-1230	M, M-7	Screw (15/64" n=28)	실체기 힌지핀 나사(15/64" n=28)	4	
G-20	15-014A-3500	M, M-7	Driving Crank(R)	요동 크랭크(後)	1	
G-21	SC-0497-1230	M, M-7	Screw (3/16" n=28)	들레 크랭크(전) 고정나사(3/16" n=28)	1	
G-22	15-015S-3500	M, M-7	Stud Screw For G-20	요동 크랭크(후) 단나사	1	
G-23	SN-0105-3400	M, M-7	Nut (15/64" n=28)	수평 운동로트 단나사 너트(15/64" n=28)	1	
G-24	15-116A-3500	M, M-7	Needle Feed Connection Rod	침송 연결로트	1	
G-25	15-017A-3500	M, M-7	Needle Feed Connection Shaft	침송 연결로트 축	1	
G-26	06-051W-7400	M, M-7	Washer For G-24	포크 쥘나사 와셔	1	
G-27	SN-0105-3400	M, M-7	Nut (15/64" n=28)	수평 운동로트 단나사 너트(15/64" n=28)	1	
G-28	SC-0316-2350	M, M-7	Screw (11/64" n=40)	스프링걸이 위치 고정나사(11/64" n=40)	1	
G-29	04-001A-5300	M, M-7	Needle Bar	바늘대(비사절)	1	
G-30	01-045M-3500	M, M-7	Gasket	가스켓	1	
G-31	01-046A-3500	M, M-7	Gasket Base	가스켓 베이스	1	
G-32	SC-0516-3500	M, M-7	Screw (3/16" n=28)	홈볼이 접시 작은나사(3/16" n=28)	4	
G-33	04-008A-2350	L-7, L	Needle Bar Bush(U)	바늘대 상붓싱	1	
G-34	04-003R-1600	L-7, L	Rubber Cap For G-33	바늘대 상붓싱 마개	1	
G-35	04-003A-257A	L-7, L	Needle Bar Bush(L)	바늘대 하붓싱(PBB)	1	
G-37	04-010A-5060	L-7, L	Slide Block Guide	슬라이드 블럭 가이드	1	
G-38	SC-0307-1230	L-7, L	Screw (3/16" n=32)	톱니 받침 크랭크 쥘나사(3/16" n=32)	3	
G-39	04-001A-5060	L-7, L	Needle Bar	바늘대	1	
G-42	04-006A-5060		Needle Bar Slide Guide Block	바늘대 안내블럭	1	
G-43	04-006C-5300		Needle Bar Thread Guide	바늘대 실 안내	1	
G-44	SC-A131-4522		Screw (1/8" n=44)	홈볼이 납작 작은나사(1/8" n=44)	1	
G-45			Needle	바늘	1	
G-46	11-017C-7507	M, M-7	Nut For G-3	와이퍼 링크 A 연결 단나사 너트	2	



Presser Foot &
Tension Release Mechanism
노루발 및 실 늦추기 관계

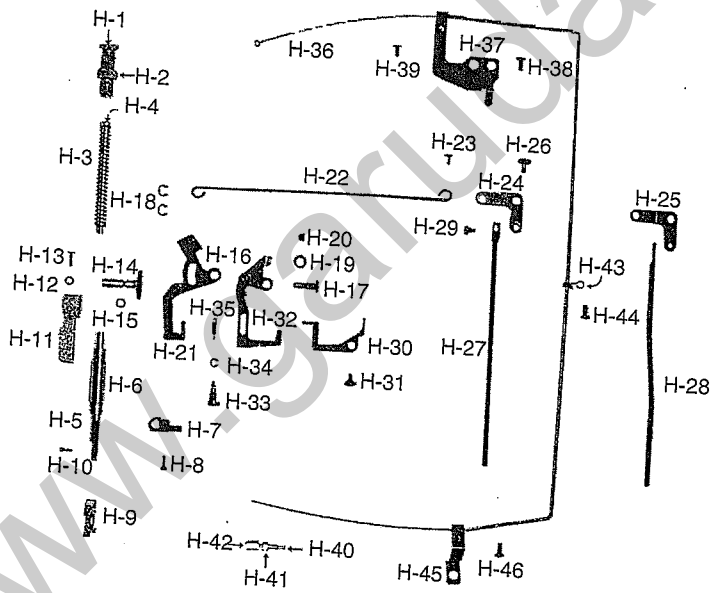

Ref. No.	Parts No.	Note	Name of Parts	품 명	Q'ty	Assembly No.
H-1	SC-0339-1230		Screw (9/16" n=20)	압력 조절나사(9/16" n=20)	1	
H-2	05-002C-2500		Presser Adjusting Nut	압력 조절나사 너트	1	
H-3	05-014C-250A		Presser Adjusting Spring	압력 조절스프링(A-Type)	1	
H-4	05-007C-1230		Presser Adjusting Bar	압력 조절봉	1	
H-5	05-206A-5300		Presser Bar	누름대	1	
H-6	05-115A-2500		Presser Bar Bushing	누름대 붓싱	1	
H-7	05-108A-3500		Presser Bar Holder	누름대 잡이	1	
H-8	SC-0174-811H		Screw (11/64" n=40)	어스나사(11/64" n=40)	1	
H-9	05-010A-5300		Presser Foot Ass'y	노루발	1조	
H-10	SC-0157-1230		Screw (9/64" n=40)	노루발 쥘나사	1	
H-11	43-001A-2500		Presser Lifter	누름대 올리기	1	
H-12	02-019W-1230		Washer For H-11	상축 헬트 와셔	1	
H-13	SC-0158-3710		Screw (9/64" n=40)	홈볼이 둥근납작 작은나사(9/64" n=40)	1	
H-14	43-102A-2500		Cam Shaft For Presser Bar	누름대 올리기 캠축	1	
H-15	02-016R-1230		O-Ring For H-14	상축 유량 조절핀 오링	1	
H-16	43-103A-2500		Presser Lifter Link	누름대 올리기 링크	1조	
H-17	43-004S-3500		Hinge Screw For H-16	수동 올림 링크 힌지나사	1	
H-18	04-009C-3710		E-Ring (φ5)	E링 (φ5)	2	
H-19	43-005A-3500		Collar For Trust	트러스트 카라	1	
H-20	SC-0502-2302		Screw (9/64" n=40)	윗뚜껑 고정판 고정나사(대)	1	
H-21	43-106C-3500		Presser Lifter Lever	누름대 올림 레버	1	
H-22	43-106C-2500		Presser Lifter Connection Bar	누름대 올리기 연결봉	1	
H-23	43-007S-2500		Stud Screw For H-22	누름대 올리기 연결봉 단나사	1	
H-24	43-108A-2500	L, L-7	Knee Lifting Link	무릎 올림 링크	1	
H-25	43-108A-3500	M, M-7	Knee Lifting Link	무릎 올림 링크	1	
H-26	43-014S-1600		Hinge Screw for H-24, 25	무릎 올림 링크 힌지나사	1	
H-27	43-109C-2500	L, L-7	Knee Lifting Bar	무릎 올림봉	1	
H-28	43-109C-3500	M, M-7	Knee Lifting Bar	무릎 올림봉	1	
H-29	43-010S-2500		Hinge Screw For H-27, 28	무릎 올림봉 힌지나사	1	
H-30	40-014A-5300		Tension Release Link	실늑추기 링크	1	
H-31	40-006S-3500		Screw For H-30	실늑추기 링크 단나사	1	
H-32	40-016A-5300		Tension Release Plate	실늑추기 판(組)	1조	
H-33	40-008S-3500		Hinge Screw For H-32	실늑추기 판 힌지나사	1	
H-34	04-009C-3710		E-Ring (φ5)	E링 (φ5)	1	
H-35	40-009G-3500		Spring For H-32	실늑추기 스프링	1	
H-36	40-008A-2500	L-7, M-7	Tension Release Cable (Ass'y)	실늑추기 케이블(組)	1조	
H-37	40-109A-257A	L-7, M-7	Cable Holder(U)	케이블잡이(U)	1	
H-38	SC-0516-3500	L-7, M-7	Screw (3/16" n=28)	가스킷 쥘나사(11/64" n=40)	1	
H-39	SC-0543-2302	L-7, M-7	Screw (11/64" n=40)	홈볼이 둥근납작 작은나사	1	
H-40	40-003A-2700	L-7, M-7	Cable Connection Bolt	케이블 연결 볼트	1	
H-41	40-005C-2700	L-7, M-7	Nut "B" For H-41	케이블 연결 너트(B)	1	
H-42	40-004C-2700	L-7, M-7	Nut "A" For H-41	케이블 연결 너트(A)	1	
H-43	44-026G-7400	L-7, M-7	Tension Release Cable Holder(M)	헬트잡이 스프링	1	
H-44	SC-0548-7400	L-7, M-7	Screw(3/16" n=28)	다이알판 쥘나사(L)	1	
H-45	40-210A-257A	L-7, M-7	Tension Release Cable Holder	케이블잡이	1	
H-46	SC-0543-2302	L-7, M-7	Screw (11/64" n=40)	톱 카바 힌지 고정나사	1	

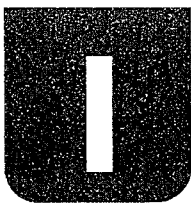

Thread Wiper Mechanism

와이퍼 관계

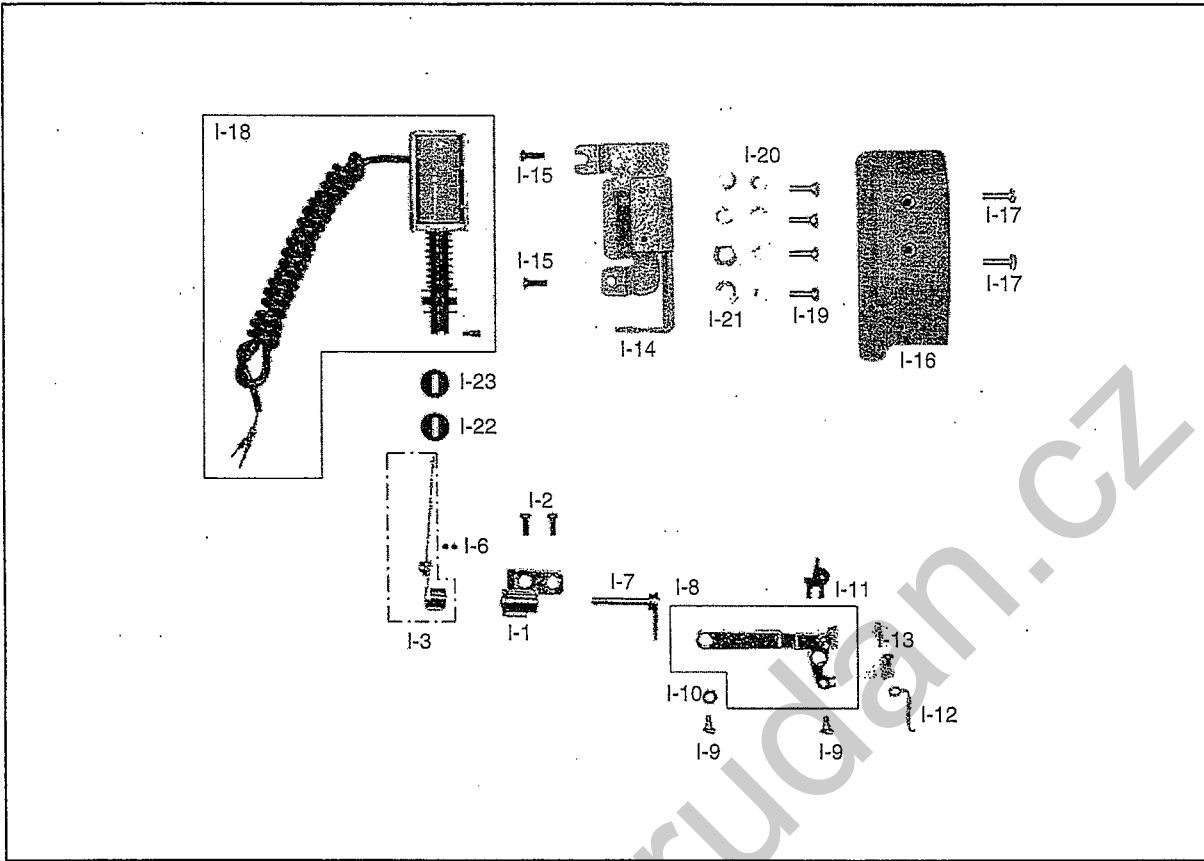

20

Ref. No.	Parts No.	Note	Name of Parts	품 명	Q'ty	Assembly No.
I-1	11-001A-5307	L-7, M-7	Wiper Bracket Ass'y	와이퍼 브라켓(組)	1	
I-2	SC-0548-7400	L-7, M-7	Screw (3/16" n=28)	다이알판 컴나사(3/16" n=28)	2	
I-3	11-030A-5307	L-7, M-7	Wiper Lever "A" Ass'y	와이퍼 레버"A"(組)	1	
I-6	SC-0105-7500	L-7, M-7	Screw (M4)	동메스 축 카라 고정나사(M4)	2	
I-7	11-060A-5307	L-7, M-7	Wiper Lever "B" Ass'y	와이퍼 레버"B"(組)	1	
I-8	11-007A-5307	L-7, M-7	Wiper Crank Ass'y	와이퍼 크랭크(組)	1	
I-9	11-013S-5060	L-7, M-7	Stud Screw For I-8	와이퍼 크랭크(組) 단나사	2	
I-10	SN-0101-1600	L-7, M-7	Nut (11/64" n=40)	스프링걸이 축 나사너트(11/64" n=40)	1	
I-11	11-010A-5307	L-7, M-7	Wiper Crank Base	와이퍼 크랭크 베이스	1	
I-12	11-011A-5307	L-7, M-7	Wiper	와이퍼	1	
I-13	SC-0531-2302	L-7, M-7	Screw (9/64" n=40)	톱카바 고정판 고정나사(소)(9/64" n=40)	1	
I-14	11-013A-5307	L-7, M-7	Wiper Base	와이퍼 베이스	1	
I-15	SC-0548-7400	L-7, M-7	Screw (3/16" n=28)	다이알판 컴나사(3/16" n=28)	2	
I-16	11-013C-257A	L-7, M-7	Wiper Cover	와이퍼 커버	1	
I-17	SC-0120-1230	L-7, M-7	Screw (9/64" n=40)	오일펌프 카바나사(9/64" n=40)	2	
I-18	11-015A-5067	L-7, M-7	Wiper Solenoid Ass'y	와이퍼 솔레노이드(組)	1	
I-19	SC-0196-2700	L-7, M-7	Screw (M3×0.5)	솔레노이드 부착 고정나사(M3×0.5)	4	
I-20	11-016W-2700	L-7, M-7	Spring Washer For I-18	솔레노이드 부착 스프링 와셔	4	
I-21	11-017W-2700	L-7, M-7	Washer For I-18	솔레노이드 부착 평와셔	4	
I-22	11-020W-5307	L-7, M-7	Stopper Washer For I-18	와이퍼 솔레노이드 스톱퍼 와셔	1	
I-23	11-021R-5307	L-7, M-7	Stopper Rubber Washer For I-18	와이퍼 솔레노이드 고무와셔	1	

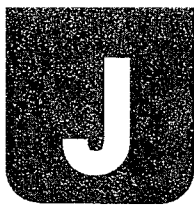

Reverse Button Mechanism

역진 버튼 관계

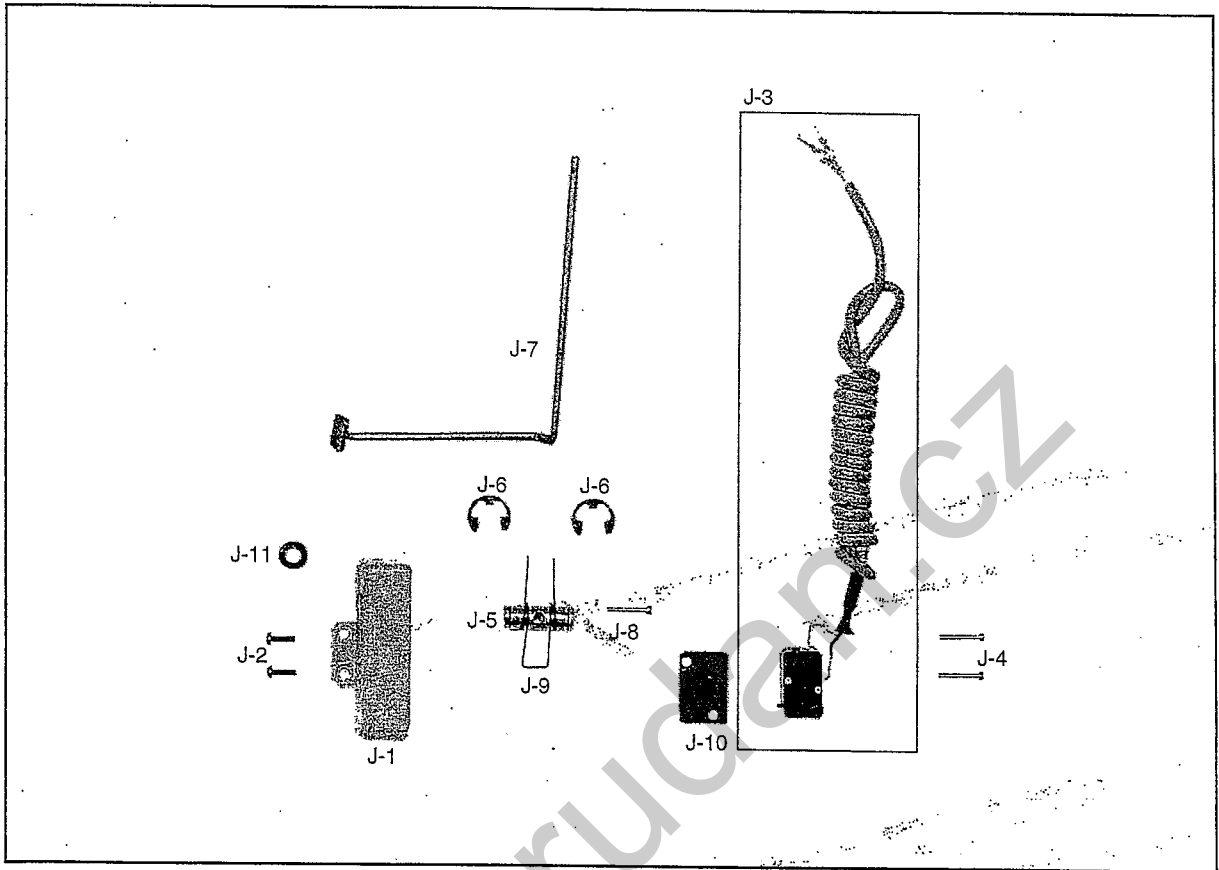

Ref. No.	Parts No.	Note	Name of Parts	품 명	Q ty	Assembly No.
J-1	12-001A-5607	L-7, M-7	Reverse Button Case	버튼 케이스	1	
J-2	SC-0523-1230	L-7, M-7	Screw (9/64" n=40)	무릎올림 링크 고정나사(9/64" n=40)	2	
J-3	12-131A-5607	L-7, M-7	Reverse Button S/W (Ass'y)	역진 버튼 스위치(조)	1	
J-4	12-012S-2700	L-7, M-7	Screw (M2×0.4)	스위치 고정 볼트	2	
J-5	12-104P-5607	L-7, M-7	Reverse Button Actuator Pin	역진 버튼 작동핀	1	
J-6	43-009C-1600	L-7, M-7	E-Ring (φ 9)	제어체 축링(φ링 9)	2	
J-7	12-007A-5307	L-7, M-7	Reverse Feed Control Lever	역진 버튼 작동 레버(조)	1	
J-8	SC-0178-7400	L-7, M-7	Screw (11/64" n=40)	윗뚜껑 접나사(11/64" n=40)	1	
J-9	12-008G-5607	L-7, M-7	Spring For J-7	역진 버튼 스위치 누름대 스프링	1	
J-10	12-009R-5607	L-7, M-7	Insulated Rubber	스위치 받침 절연 고무	1	
J-11	12-010A-5607	L-7, M-7	Reverse Button Cable Bushing	역진 버튼 케이블 붓싱	1	

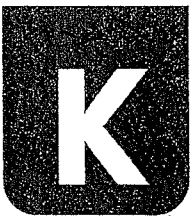

Program Unit Box & Auto presser
Lifting Solenoid Mechanism
프로그램 유니트 박스 및 자동 무릎 올림 관계

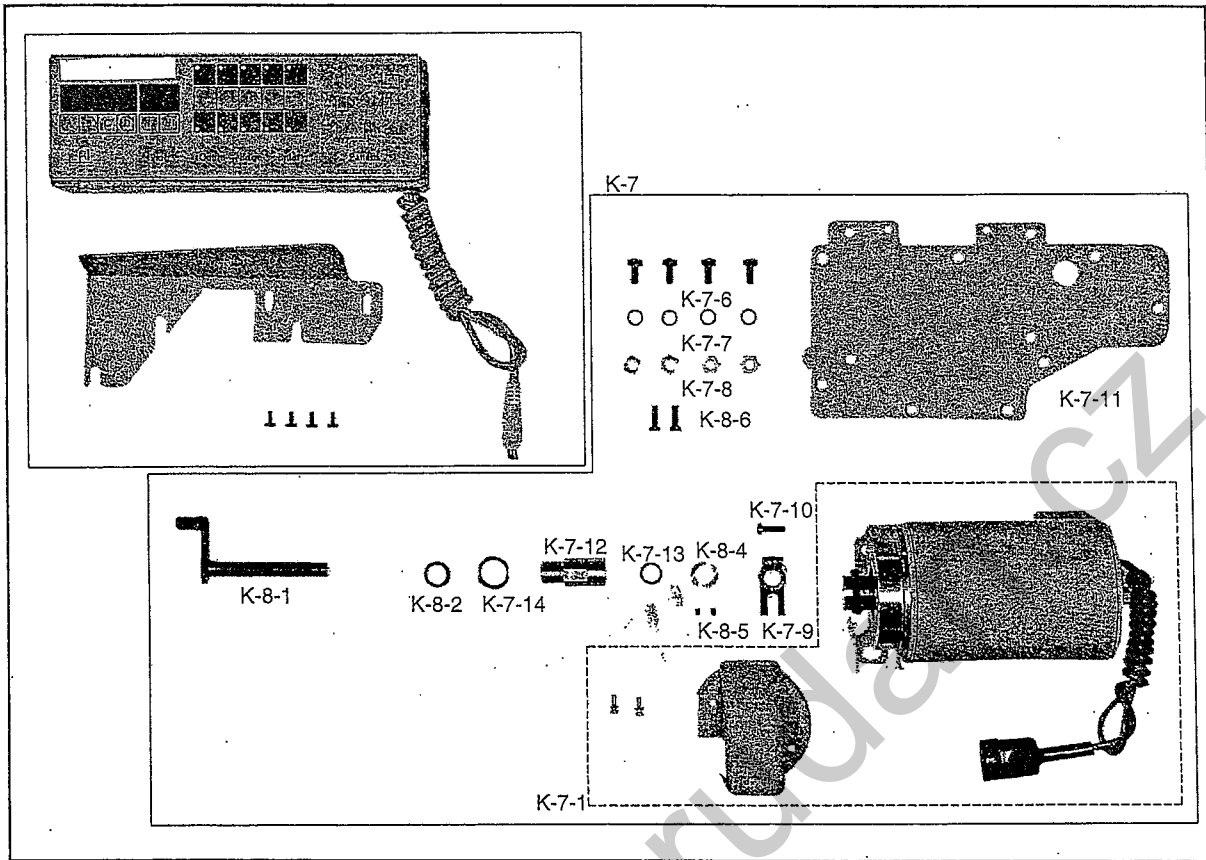

22

Ref. No.	Parts No.	Note	Name of Parts	品 名	Qty	Assembly No.
K-7	KM-2507	L-7, M-7	Auto Knee Lifter Solenoid Ass'y	자동무릎 올림 솔레노이드(조)	1	
K-7-1	HEC-2507	L-7, M-7	Auto Knee Lifter Solenoid	자동무릎 올림 장치(SPF-5)	(1조)	
K-7-6	SC-0183-2700	L-7, M-7	Screw (15/64" n=28)	베이스 고정나사(B)(15/64" n=28)	(4)	
K-7-7	06-051W-7400	L-7, M-7	Washer For K-7-4, K-7-5	포크 접나사 와셔	6	
K-7-8	SN-0121-7400	L-7, M-7	Nut (15/64" n=28)	세구멍 실결이 너트(15/64" n=28)	(4)	
K-7-9	43-013A-257A	L-7, M-7	Knee Lifter Connection Crank	자동무릎 올림 연결 크랭크(AK)	(1)	
K-7-10	SC-0497-1230	L-7, M-7	Screw (3/16" n=28)	들레 크랭크(전) 고정나사(3/16" n=28)	(1)	
K-7-11	43-014A-257A	L-7, M-7	Back Cover For Knee Lifter	자동무릎 올림 뒷뚜껑(AK)	(1)	
K-7-12	43-015A-257A	L-7, M-7	Knee Lifter Shaft Bushing	자동무릎 올림축 붓싱(AK)	(1)	K-7 (option)
K-7-13	43-016R-257A	L-7, M-7	Oil Seal For K-7-12	자동무릎 올림축 오일셀(AK)	(1)	
K-7-14	43-017C-257A	L-7, M-7	Nut For Knee Lifter	자동무릎 올림 너트(AK)	(1)	
K-8-1	43-018A-257A	L-7, M-7	Knee Lifter Shaft	자동무릎 올림축(組) (AK)	(1)	
K-8-2	06-021W-7400	L-7, M-7	Washer For K-8-1	역진 레버 와셔	(1)	
K-8-4	43-021A-257A	L-7, M-7	Collar For K-8-1	자동무릎 올림축 카라(AK)	(1)	
K-8-5	SC-0512-1230	L-7, M-7	Screw (11/64" n=40)	오일 펌프 조인트 나사(11/64" n=40)	(2)	
K-8-6	SC-0548-7400		Screw (3/16" n=28)	다이알판 접나사	(2)	



Lubrication 급유관계

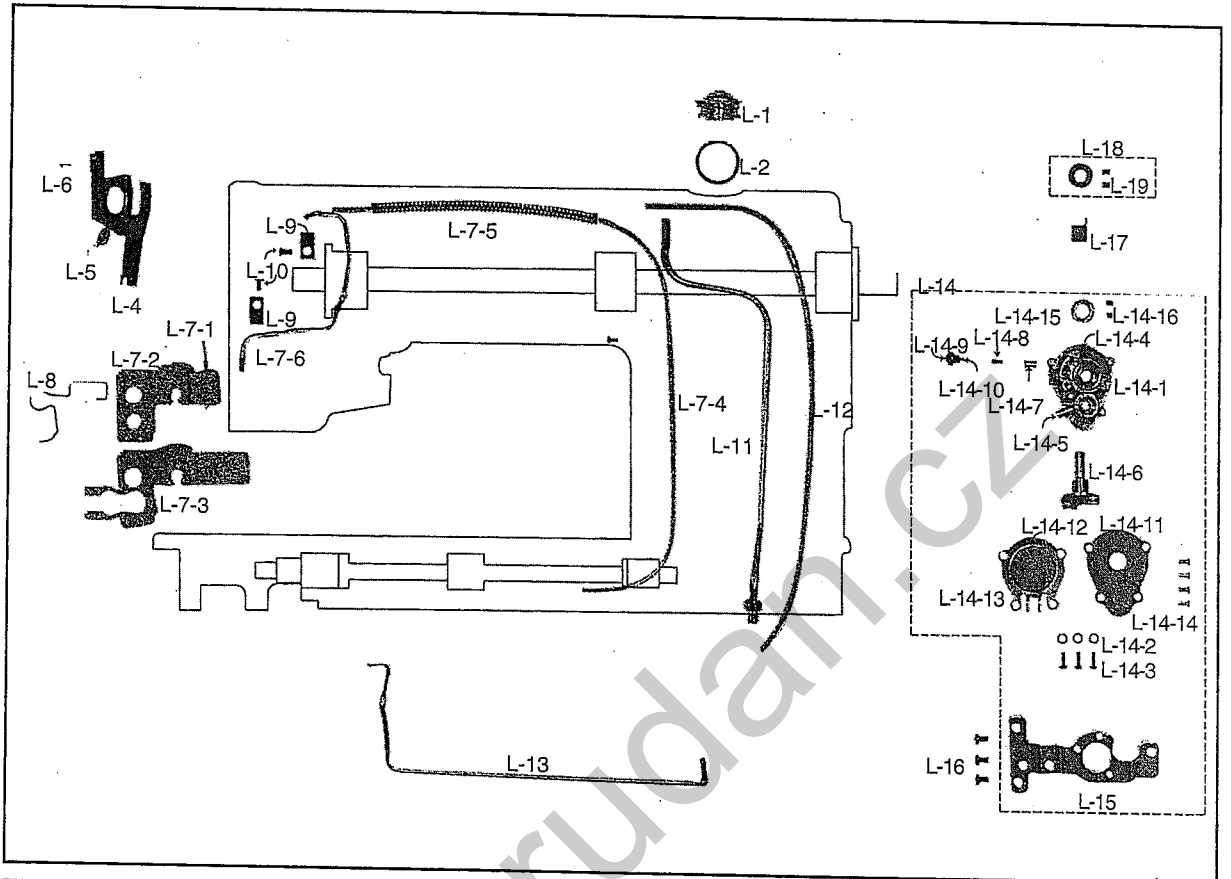

Ref. No.	Parts No.	Note	Name of Parts	品名	Q'ty	Assembly No.
L-1	44-001C-2500		Oil Gauge Window	유창	1	
L-2	44-002R-2500		O-Ring For L-1	유창 오링 (G25)	1	
L-4	44-131C-1230	L, L-7	Arm Oil Shield	바늘대 급유판	1	
L-5	44-0000-1230	L, L-7	Oil Wick	오일집지	1	
L-6	SC-0120-1230	L, L-7	Screw (9/64" n=40)	오일 펌프 카바나사(9/64" n=40)	1	
L-7-1	44-012C-1230		Oil Return Tube "A"	환류 파이프	(1)	L-7
L-7-2	44-055A-5060	L, L-7	Oil Return Felter	환류 펠트	(1)	
L-7-3	44-052C-5300	M, M-7	Oil Return Felter	환류 펠트(A)	(1)	
L-7-4	44-012C-1230		Oil Return Tube "B"	환류 파이프	(1)	
L-7-5	44-056G-5300		Return Oil Tube Spring	환류 호스 스프링	(1)	
L-7-6	44-055C-5300		Return Oil Pipe	환류 파이프	(1)	
L-8	44-048M-3500		Oil Return Felter Holder	환류 펠트잡이	1	
L-9	01-009R-2350		Oil Return Pipe Holder	케이블 잡이	2	
L-10	SC-0548-7400		Screw (3/16" n=28)	다이알판 쥘나사(3/16" n=28)	2	
L-11	44-008P-2500	L, L-7	Upper Shaft Oil Pipe Ass'y	상축 급유 파이프(組)	1조	
L-12	44-008P-3500	M, M-7	Upper Shaft Oil Tube	환류 파이프	1	
L-13	44-009P-2500		Oil Pipe For Lower Shaft	하축 급유 파이프	1	
L-14	44-150A-2500		Oil Pump Ass'y	오일 펌프(조)	1	
L-14-1	44-012A-2350		Oil Pump Body	오일 펌프 몸체	(1)	L-14
L-14-2	44-011W-1600		Washer For L-14-1	오일 펌프 몸체 쥘나사 와셔(φ4)	(3)	
L-14-3	SC-0528-1230		Screw (9/64" n=40)	몸 카바나사(우)(9/64" n=40)	(3)	
L-14-4	44-010C-1600		Nipple For Oil Return Pipe	환류 파이프 니플	(1)	
L-14-5	44-009C-1600		Oil Nipple For Lower Shaft	하축 급유 니플	(1)	
L-14-6	44-126A-1230		Impeller	임펠러	(1)	
L-14-7	44-117A-1230		Piston	피스톤	(1)	
L-14-8	44-118G-1230		Piston Spring	피스톤 스프링	(1)	
L-14-9	44-119S-1230		Pin Screw For L-14-8	피스톤 스프링 쥘나사	(1)	
L-14-10	44-120P-1230		Pin For L-14-8	피스톤 스프링 핀(RP2×8)	(1)	
L-14-11	44-004C-2350		Cover For Oil Pump	오일 펌프 커버	(1)	
L-14-12	44-024C-1230		Oil Pump Cap	오일 펌프, 헬타 캡	(1)	
L-14-13	44-105C-2500		Magnetic Holder	자석잡이	(1)	
L-14-14	SC-0120-1230		Screw (9/64" n=40)	오일 펌프 카바나사(9/64" n=40)	(4)	
L-14-15	44-119A-1230		Collar For Impeller Shaft	오일 펌프 카라	(1)	
L-14-16	SC-0512-1230		Screw (11/64" n=40)	오일 펌프 조인트 카바(조)(11/64" n=40)	(2)	
L-15	44-010A-2500		Oil Pump Bracket	오일 펌프 브라켓	1	
L-16	SC-0548-7400		Screw (3/16" n=28)	다이알판 쥘나사(3/16" n=28)	3	
L-17	44-016G-1230		Oil Pump Connection Spring	오일 펌프 조인트 스프링	1	
L-18	44-115A-1230		Oil Pump Connection Collar	오일 펌프 조인트 카라(조)	1	
L-19	SC-0542-1230		Screw (11/64" n=40)	실 뉘시기 고정나사(11/64" n=40)	2	

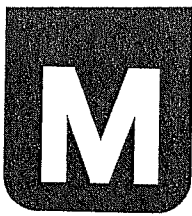

Accessories
액세서리

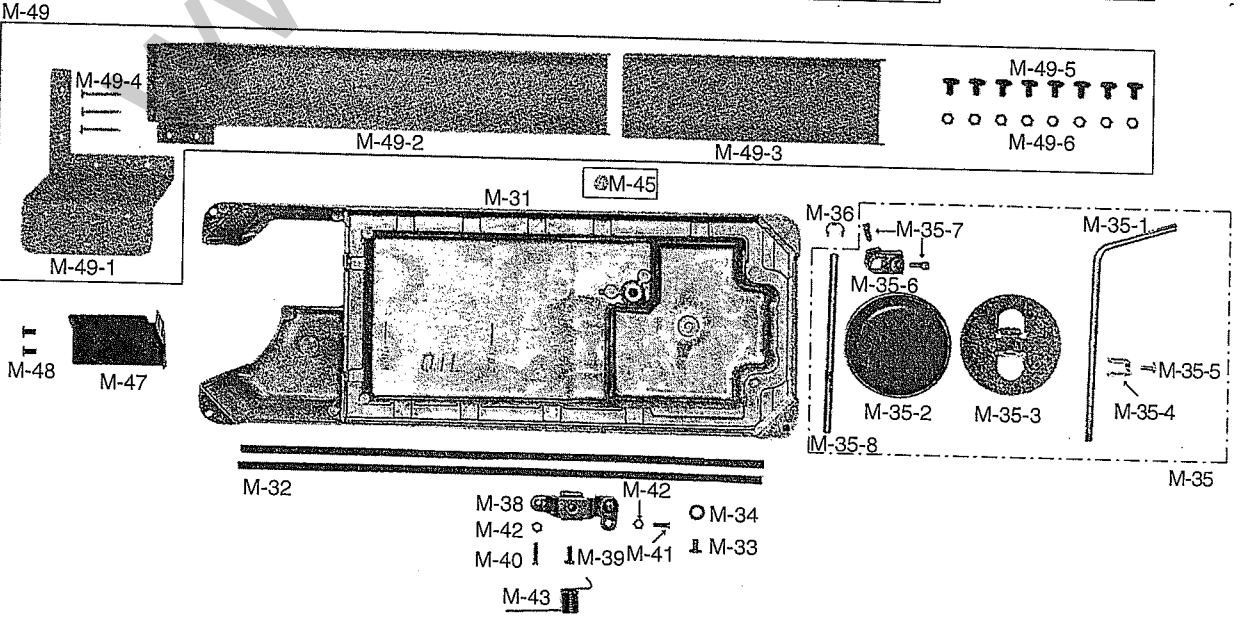
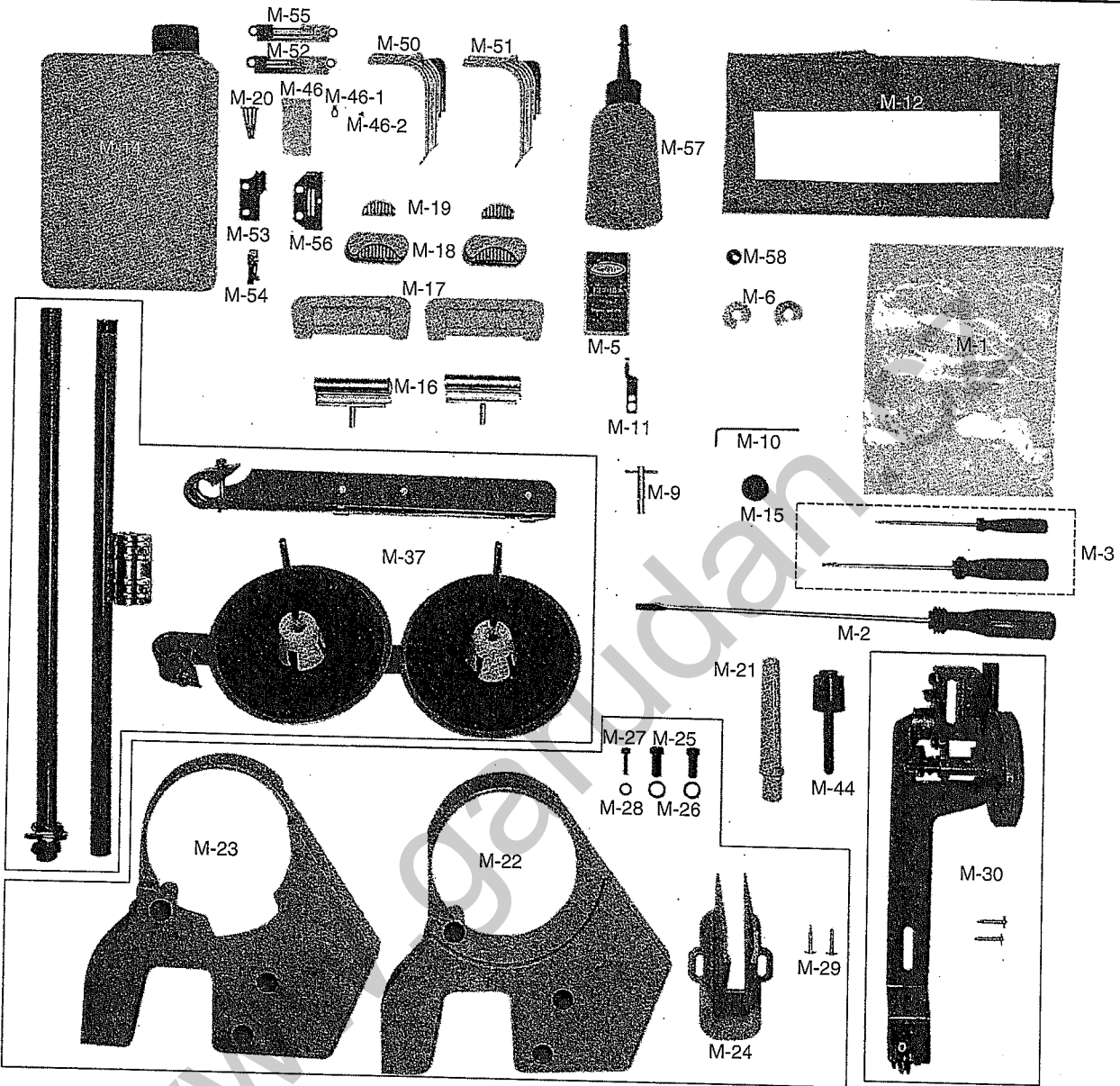

Ref. No.	Parts No.	Note	Name of Parts	품 명	Q'ty	Assembly No.
M-1	91-001C-1230		Accessory Bag	액세서리 박스	1	
M-2	91-102C-1230		Driver(Large)	드라이버(大)	1	
M-3	91-103C-1230		Driver(Middle,Small)	드라이버(中, 小)	1	
M-5			Needle	바늘	1	
M-6	07-105A-2700		Bobbin(AL)	보빈	4	
M-8	91-105C-2700	L-7, M-7	Spanner	고정 메스 장력 조절용 스패너	1	
M-9	91-001C-2700	L-7, M-7	L Wrench(2mm)	L 렌치(2mm)	1	
M-11	10-101A-2700	L-7, M-7	Fixed Mes	고정메스(7AN701)	1	
M-12	91-006C-2700		Head Cover	미싱 커버	1	
M-14	91-008C-1230		Oil Tank	오일 캔	1	
M-15	44-010C-1230		Magnetic	자석	2	
M-16	01-043C-1230		Head Hinge	힌지	2	
M-17	01-042R-1230		Rubber Cushion For Hinge	힌지 고무(大)	2	
M-18	01-214R-1230		Head Support Rubber "A"	힌지 고무(中)	2	
M-19	01-213R-1230		Head Support Rubber "B"	힌지 고무(小)	2	
M-20			Nail	못	8	
M-21	91-012C-1230		Head Rest	미싱 받침대	1	
M-22	60-001A-2500	N.P제외	Belt Cover "A"	벨트 커버 "A"	1	
M-23	60-003A-2500	N.P사양	Belt Cover(N.P)	벨트 커버 (N.P)	1	
M-24	60-002A-2500		Belt Cover "B"	벨트 커버 "B"	1	
M-25	SC-0344-8260		Screw (5/16" n=24)	포스트 고정나사(5/16" n=24)	2	
M-26	09-025W-8270		Washer For M-22, 23	새들 쥘나사 와셔	2	
M-27	SC-0184-1600		Screw (3/16" n=28)	수평릴대 크랭크 쥘나사(3/16" n=28)	1	
M-28	10-020W-2700		Washer For M-22, 23	스트퍼 쥘와셔	1	
M-29	91-002S-3400		Nail For M-24	목나사	2	
M-30	41-101A-1230		Bobbin Winder Ass'y	실감기(組)	1조	
M-31	44-030A-5300		Oil Pan	오일팬	1조	
M-32	44-003M-1230		Oil Pan Gasket	오일 가스켓	2	
M-33	SC-0347-1230		Screw (M8×1.25)	배유구멍 마개나사(M8×1.25)	1	
M-34	44-005R-1230		Packing For M-33	배유구멍 마개나사 오링	1	
M-35	43-001A-1600		Knee Lifter Pad Ass'y	무릎 올림(組)	1	
M-35-1	43-106C-1600		Knee Lifter Shaft	무릎 받침축	1	
M-35-2	43-101R-1600		Knee Lifter Pad	무릎 받침 고무	1	
M-35-3	43-102C-1600		Knee Lifter Pad Insert Plate	무릎 받침 고무 잡이판	1	
M-35-4	43-101A-1230		Holder For M-35-2	무릎 받침 고무 연결 링크	1	
M-35-5	43-108S-1230		Set Screw For M-32-4	무릎 받침 연결 링크 쥘나사	1	
M-35-6	43-106C-1230		Knee Lifter Arm Joint Complete	무릎 받침 연결 크랭크	1	
M-35-7	SC-0181-1230		Screw (5/16" n=18)	무릎받침 축 고정나사(5/16" n=18)	2	
M-35-8	43-108C-1600		Shaft For M-34-1	제어체 축	1	
M-36	43-009C-1600		E-Ring(φ9)	제어체 축 링(E링 φ9)	1	
M-37	91-007A-2302		Thread Stand Ass'y	실패 꽃이(組)	1조	
M-38	43-007A-1600		Knee Lifting Controller	제어체	1	
M-39	SC-0106-7400		Screw (15/64" n=28)	포크 쥘나사(육각)(15/64" n=28)	1	
M-40	SC-0545-1230		Screw (15/64" n=28)	제어체 운동조절나사(육)(15/64" n=28)	1	
M-41	43-002S-3500		Screw (15/64" n=28)	흡블이 받침 작은나사(15/64" n=28)	1	
M-42	SN-0105-3400		Nut (15/64" n=28)	수평운동로드 단나사너트(15/64" n=28)	2	
M-43	43-008G-1600		Spring For M-38	제어체 스프링	1	
M-44	43-010A-1600		Knee Base Rubber	무릎 올림봉 받침 캡	1	
M-45	04-104R-1230	N.P사양	Oil Cap	바늘대 상부심 마개	1	
M-46	01-050A-5307		Sub Needle Plate Cover	보조 침판 커버	1	
M-46-1	01-051A-5300		Fixed Plate For M-37	커버 고정판	1	
M-46-2	01-052S-5300		Screw (1/4" n=44)	흡블이 납작 작은나사(1/4" n=44)	1	
M-47	44-026A-5300		Chip Shute Guide(L)	칩 배출 가이드(下)	1	
M-48	SC-0543-2302		Screw (11/64" n=40)	톱 카바 힌지 고정나사(11/64" n=40)	2	
M-49-1	90-041A-5300		Table Holder	테이블 부착판	1	
M-49-2	90-043A-5300		Chip Shute Plate(U)	칩 배출판(上)	1	
M-49-3	90-044A-5300		Chip Shute Plate(L)	칩 배출판(下)	1	
M-49-4	91-002S-3400		Nail For M-40-1	목나사	3	
M-49-5	SC-0525-5300		Screw (11/64" n=40)	메스 구동링크 축 쥘나사(11/64" n=40)	8	
M-49-6	SN-0101-1600		Nut (11/64" n=40)	스프링걸이 축 나사너트(11/64" n=40)	8	
M-50	13-153A-5300	L, M	Hook Protect Plate (1/8")	훅 보호판(비사절 1/8")	1	
M-51	13-051A-5300	L-7, M-7	Hook Protect Plate (1/4")	훅 보호판(사절 1/8")	1	
M-52	01-035A-5060	L, L-7	Needle Plate(1/8")	침판(1/8")	1	
M-53	06-107A-5060	L, L-7	Feed Dog(1/8")	톱니(1/8")	1	
M-54	05-010A-5300		Presser Foot(1/8")	노루발(1/8")	1	
M-55	01-035A-5300	M, M-7	Needle Plate(1/8")	침판(1/8")	1	
M-56	06-138A-5300	M, M-7	Feed Dog (1/8")	톱니(1/8")	1	
M-57	91-011C-1230		Oil Tank	유차	1	
M-58	44-011R-2350		Packing	오일팬 누유방지 고무	1	

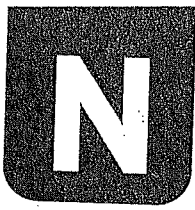

Special Parts

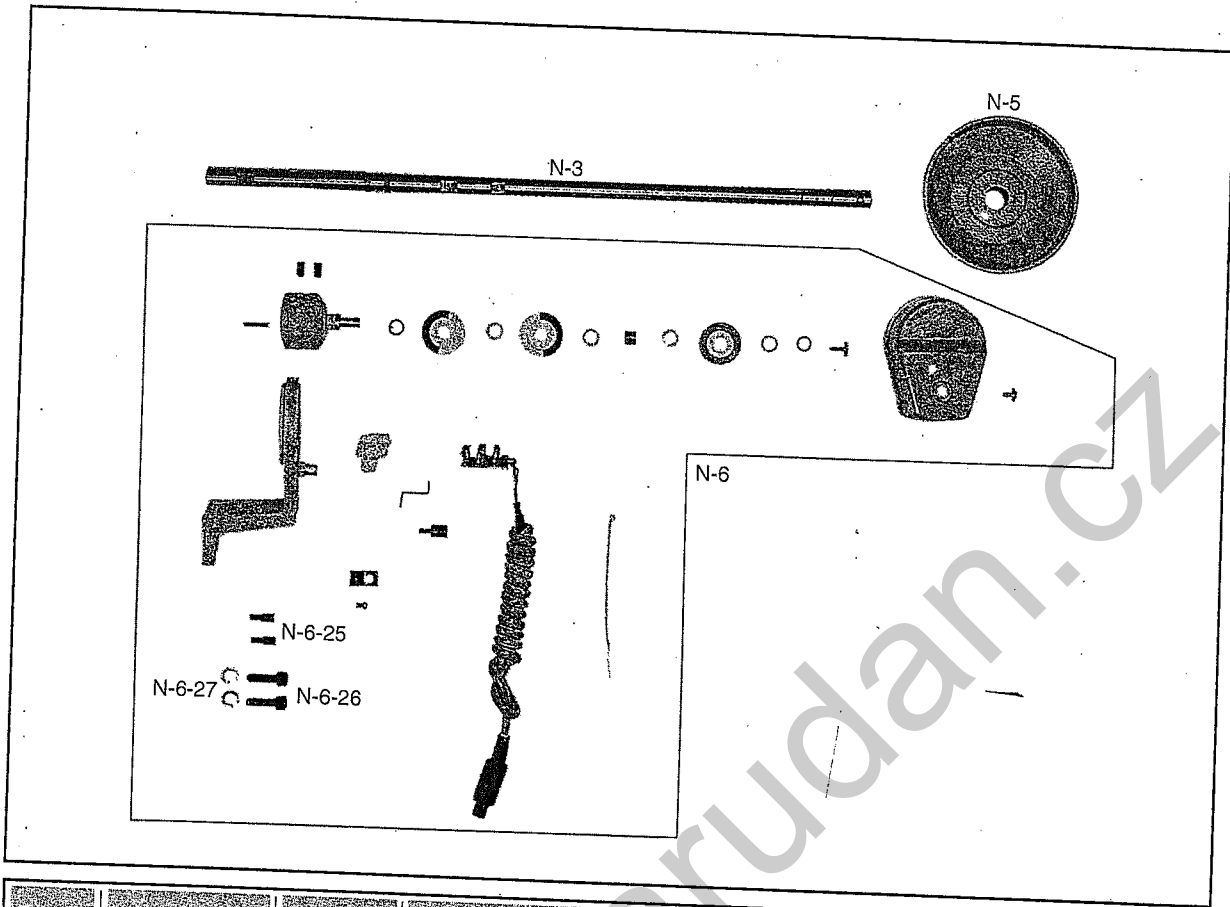

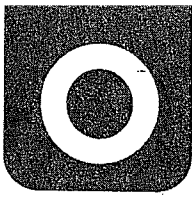

Ref. No.	Parts No.	Note	Name of Parts	품명	Q'ty	Assembly No.
N-3	02-101A-537N		Main Shaft	주축(MP) L=431	1	
N-5	02-003A-2350		Pulley	풀리	1	
N-6	12-0000-4701		Synchronizer Ass'y	싱크로나이저(조)	1	
N-6-25	01-019P-2350		Guide Pin For Synchronizer	싱크로 베이스 기준핀	(2)	N-6
N-6-26	SC-0108-2350		Screw (M6)	육각구멍볼트 보울트(M6)	(2)	
N-6-27	01-020W-2350		Washer For Synchronizer	싱크로 베이스 스프링 와셔	(2)	





Gauge Parts
게이지 관계

GF-116 Serie

Name of Parts Gauge Size	Needle Plate	Feed Dog	Presser Foot
	 (A-31)	 (D-42)	 (H-9)
1/8" (3.2mm)	01-035A-5060	06-107A-5060	05-010A-5300
5/32" (4mm)	01-210A-5060	06-107A-5060	05-111A-5300
3/16" (4.8mm)	01-310A-5060	06-107A-5060	05-111A-5300
7/32" (5.6mm)	01-410A-5060	06-107A-123A	05-112A-5300
1/4" (6.4mm)	01-036A-5060	06-107A-123A	05-112A-5300
3/8" (9.5mm)	01-510A-5060	06-107A-123A	05-112A-5300

GF-118 Serie

Name of Parts Gauge Size	Needle Plate	Feed Dog	Presser Foot
	 (A-32)	 (D-43)	 (H-9)
1/8" (3.2mm)	01-035A-5300	06-138A-5300	05-010A-5300
5/32" (4mm)	01-111A-5300	06-138A-5300	05-111A-5300
3/16" (4.8mm)	01-112A-5300	06-138A-5300	05-111A-5300
7/32" (5.6mm)	01-113A-5300	06-111A-5300	05-112A-5300
1/4" (6.4mm)	01-114A-5300	06-111A-5300	05-112A-5300
3/8" (9.5mm)	01-115A-5300	06-111A-5300	05-112A-5300

수정 리스트 Changed Parts List

No	Ref. No	Parts No	Name of Parts	Contents	Date	Old Parts No.	Remarks
1	C-16	07-010A-1230	Lower Shaft Bushing(R)	Substitution	98. 2	07-002A-1600	98. 3/4
2	F-51-1	SC-0513-4515	Screw(1/8" n=44)	Additional Parts	98. 3		
3	K-7-15		Hinge Screw	Deleted Parts	98. 3	15-008S-3400	
4	K-7-16		Spring for K-8-1	Deleted Parts	98. 3	43-019G-257A	
5	K-8-3		E-Ring(@8)	Deleted Parts	98. 3	40-002C-2350	
6	M-50	13-153A-5300	Hook Protect Plate(1/8")	Only for Regular M/C	98. 4	13-151A-5300	
7	F-60-1	13-151A-5300	Hook Protect Plate(1/4")	Only for Regular M/C	98. 4	13-053A-5300	
8	J-4	12-012S-2700	Screw	Substitution	98. 4	SC-0337-4125	
9	M-51	13-051A-5300	Hook Protect Plate(1/8")	Only for Trimming M/C	98. 4		
10	F-60	13-053A-5300	Hook Protect Plate(1/4")	Only for Trimming M/C	98. 4	13-053A-5300	
11	C-26-1	07-001A-357A	Rotary Hook Ass'y	Additional Parts	98. 5		
12	M-30	41-101A-1230	Bobbin Winder Ass'y	Substitution	98. 6	41-001A-1230	
13	A-28	02-003A-2700	Nylon Clip	Substitution	98. 8	01-009R-2700	
14	D-47	06-020S-1230	Screw(3/16" n=32)	Substitution	98. 8	SC-0173-4118	
15	B-15	02-005A-2500	Upper Shaft Bushing(M)	Substitution	98. 8	02-005A-3500	
16	L-20		Oil Nipple(U)	Deleted Parts	98. 8	44-010S-3500	
17	L-21		Oil Nipple(L)	Deleted Parts	98. 8	44-011S-3500	
18	L-12	44-008P-3500	Upper Shaft Oil Pipe	Change of Blue Point	98. 8	44-012C-3500	98. 4/4
19	E-27	10-067S-7507	Stud Screw for E-26	Substitution	98. 9	10-020S-257A	
20	A-16	04-104R-1230	Arm Rubber Cap	Substitution	98. 10	01-112R-1230	
21	A-41	01-035P-1370	Machine Number Plate	Substitution	98. 10	01-035P-2500	
22	A-33	SC-A119-4119	Screw(11/64" n=40)	Substitution	98. 10	01-136S-1230	
23	A-36	SC-A119-4119	Screw(11/64" n=40)	Substitution	98. 10	01-136S-1230	
24	B-23-1	02-007A-2500	Pulley(Only for Regular M/C)	Change of Blue Point	98. 12	02-007A-257A	
25	E-9	10-002A-257A	Rotary Mes	Change of Blue Point	98. 12	10-006A-2700	
26	E-15	10-015A-5307	Thread Trimming Lever Connecting Link	Substitution	98. 10	10-012A-257A	
27	F-21	13-021C-5300	Snap Ring for F-20	Change of Blue Point	98. 8	13-021R-5300	
28	G-43	04-006C-5300	Needle Bar Thread Guide	Substitution	98. 10	04-004C-5300	
29	I-9	11-013S-5060	Stud Screw for I-8	Substitution	98. 11	16-113S-3710	
30	G-42	04-006A-5060	Needle Bar Slide Guide Block	Change of Blue Point	99. 1	04-005A-2500	99. 1/4
31	F-40	13-140A-5300	Mes Driving Shaft Bushing	Change of Blue Point	99. 1	13-040A-5300	
32	F-45	13-146A-5300	Mes Mounting Base	Change of Blue Point	99. 1	13-046A-5300	
33	E-27-1	07-011W-1230	Washer for E-27-1	Additional Parts	99. 2		
34	A-47	SC-0104-4517	Screw(11/64" n=40)	Substitution	99. 3	SC-0542-4515	
35	B-28	SC-0504-4515	Screw(1/4" n=40)	Substitution	99. 3	SC-A129-4515	
36	B-28-1	SC-0129-4515	Screw(1/4" n=40)	Substitution	99. 3	SC-A129-4515	
37	B-31	SC-0507-4515	Screw(15/64" n=28)	Substitution	99. 3	SC-0114-4515	
38	C-6	SC-0507-4515	Screw(15/64" n=28)	Substitution	99. 3	SC-0114-4515	
39	C-25	SC-0104-4517	Screw(11/64" n=40)	Substitution	99. 3	SC-0542-4515	
40	D-75	SC-0158-4122	Screw(9/64" n=40)	Substitution	99. 3	SC-0528-4125	

NOTE)

수정 리스트 Changed Parts List

No.	Ref No.	Parts No.	Name of Parts	Contents	Date	Old Parts No.	Remarks
41	F-8	SC-0507-4515	Screw(15/64" n=28)	Substitution	99. 3	SC-0114-4515	
42	F-39	SC-0158-4122	Screw(9/64" n=40)	Substitution	99. 3	SC-0528-4125	
43	H-13	SC-0158-4122	Screw(9/64" n=40)	Substitution	99. 3	SC-0528-4125	
44	H-20	SC-0502-4125	Screw(11/64" n=40)	Substitution	99. 3	SC-0531-4125	
45	H-39	SC-0543-4525	Screw(11/64" n=40)	Substitution	99. 3	SC-0175-4522	
46	H-46	SC-0543-4525	Screw(9/64" n=40)	Substitution	99. 3	SC-0175-4522	
47	J-2	SC-0523-4122	Screw(9/64" n=42)	Substitution	99. 3	SC-0528-4125	
48	M-41	43-002S-3500	Screw(15/64" n=28)	Substitution	99. 3	SC-0546-4518	
49	M-46-2	01-052S-5300	Screw(1/4" n=44)	Substitution	99. 3	SC-0133-4122	
50	C-4	03-002A-1230	Upright Shaft Bushing(U)	Substitution	99. 8	03-002A-257A	
51	C-15	07-010A-1230	Lower Shaft Bushing(R)	Substitution	99. 8	07-006A-257A	
52	B-20	02-006A-257B	Upper Shaft Bushing(R)	Substitution	99. 8	02-006A-257A	
53	A-46	40-001A-2700	Sub Upper Thread Tension Control Ass'y	Substitution	99. 8	40-001A-257A	
54	B-12	02-015A-5300	Upper Shaft Bushing(F)	Substitution	99. 8	02-014A-5307	
55	M-52	01-035A-5060	Needle Plate(1/8")	Additional Parts	99. 8		
56	M-53	06-007A-5060	Feed Dog(1/8")	Additional Parts	99. 8		
57	M-54	05-010A-5300	Presser Foot(1/8")	Additional Parts	99. 8		
58	M-55	01-035A-5300	Needle Plate(1/8")	Additional Parts	99. 8		
59	M-56	06-038A-5300	Feed Dog(1/8")	Additional Parts	99. 8		
60	M-57	91-011C-1230	Oil Tank	Additional Parts	99. 8		
61	M-58	44-011R-2350	Packing	Additional Parts			
62	M-13		Head Cover	Deleted Parts	00. 3	91-013C-1230	00. 1/4
63	B-2	02-015C-2500	Oil Adjusting Pin for B-1	Substitution	00. 3	02-015C-2350	
64	B-2-1		Spring for B-2	Deleted Parts	00. 3	02-017G-1230	
65	B-4	02-018W-1230	Rubber for B-2	Substitution	00. 3	02-118W-1230	
66	B-6		Washer for B-2	Deleted Parts	00. 3	02-019W-1230	
67	F-62	01-052S-5300	Screw(1/8" n=44)	Substitution	00. 8	SC-0133-4122	
68	M-19	01-213R-1230	Hinge Rubber(S)	Change of Blue Point	01. 03	01-013R-1230	
69	M-18	01-214R-1230	Hinge Rubber(M)	Change of Blue Point	01. 03	01-014R-1230	
70	A-7	SC-0523-1230	Screw(3/16" n=28)	Substitution	01. 10	SC-0523-4122	
71	A-9	SC-0548-7400	Screw(3/16" n=28)	Substitution	01. 10	SC-0548-4122	
72	A-14	SC-0523-1230	Screw(3/16" n=28)	Substitution	01. 10	SC-0523-4122	
73	A-22	SC-0346-2350	Screw(M8×1.25)	Substitution	01. 10	SC-0346-4113	
74	A-24	SN-0112-1230	Nut(M8×1.25)	Substitution	01. 10	SN-0112-4000	
75	A-47	SC-0104-5607	Screw(11/64" n=40)	Substitution	01. 10	SC-0104-4517	
76	A-48	01-127A-1230	Three Hole Thread Guide Ass'y	Substitution	01. 10	01-027A-1230	
77	A-51	SC-0120-1230	Screw(9/64" n=40)	Substitution	01. 10	SC-0120-2118	
78	A-53	SC-1230-1230	Screw(9/64" n=40)	Substitution	01. 10	SC-0120-2118	
79	A-57	SC-0114-1230	Screw(15/64" n=28)	Substitution	01. 10	SC-0114-4515	
80	A-60	SC-0539-5050	Screw(9/64" n=40)	Substitution	01. 10	SC-0539-3125	

NOTE)

수정 리스트

Changed Parts List

No.	Ref. No.	Parts No.	Name of Parts	Contents	Date	Old Parts No.	Remarks
81	M-6	07-105A-2700	Bobbin(AL)	Substitution	01. 10	07-005A-2700	
82	C-10-1	07-103A-2500	Lower Shaft	Substitution	01. 10	07-003A-2500	
83	M-7	07-105A-2700	Bobbin(Steel)	Substitution	01. 10	07-008A-1230	
84	M-53	06-107A-5060	Feed Dog	Substitution	01. 10	06-007A-5060	
85	M-56	06-138A-5300	Feed Dog	Substitution	01. 10	06-038A-5300	
86	D-42	06-107A-5060	Feed Dog	Substitution	01. 10	06-007A-5060	
87	D-43	06-138A-5300	Feed Dog	Substitution	01. 10	06-038A-5300	
88	B-1	02-101A-5300	Upper Shaft	Substitution	01. 10	02-001A-5300	
89	B-2	02-115C-2500	Oil Adjusting Pin B-1	Substitution	01. 10	02-015C-2500	
90	B-9	SC-0123-1230	Screw(9/32" n=28)	Substitution	01. 10	SC-0123-4422	
91	B-13	02-115A-5300	Upper Shaft Bushing(F)	Substitution	01. 10	02-015A-5300	
92	B-14	02-105A-2500	Upper Shaft Bushing(M)	Substitution	01. 10	02-005A-2500	
93	B-16	02-121A-1230	Upper Shaft Collar	Substitution	01. 10	02-021A-1230	
94	B-21	02-106A-257B	Upper Shaft Bushing(R)	Substitution	01. 10	02-006A-257B	
95	B-25	SC-0150-2500	Screw(15/64" n=28)	Substitution	01. 10	SC-0150-4122	
96	B-26	SC-0188-1230	Screw(5/16" n=24)	Substitution	01. 10	SC-0188-4124	
97	B-28	SC-0504-1230	Screw(1/4" n=40)	Substitution	01. 10	SC-0504-4515	
98	B-28-1	SC-0129-7400	Screw(1/4" n=40)	Substitution	01. 10	SC-0129-4515	
99	B-31	SC-0507-1230	Screw(15/64" n=28)	Substitution	01. 10	SC-0507-4515	
100	B-35	SC-0507-1230	Screw(15/64" n=28)	Substitution	01. 10	SC-0507-4515	
101	B-34	11-0000-2507	Synchronizer Ass'y	Substitution	01. 10	12-0000-2507	
102	C-5	03-102A-1230	Upright Shaft Bushing	Substitution	01. 10	03-002A-1230	
103	C-16	07-110A-1230	Lower Shaft Bushing	Substitution	01. 10	07-010A-1230	
104	C-17	SC-0507-1230	Screw(15/64" n=28)	Substitution	01. 10	SC-0507-4515	
105	C-18	07-103A-1600	Lower Shaft Bushing	Substitution	01. 10	07-003A-1600	
106	C-21	SC-0114-1230	Screw(15/64" n=28)	Substitution	01. 10	SC-0114-4515	
107	C-22	SC-0361-1230	Screw(3/16" n=32)	Substitution	01. 10	SC-0361-4122	
108	C-25	SC-0104-5607	Screw(11/64" n=40)	Substitution	01. 10	SC-0104-4517	
109	C-28	07-105A-2700	Bobbin(AL)	Substitution	01. 10	07-005A-2700	
110	C-33	SC-0174-1230	Screw(11/64" n=40)	Substitution	01. 10	SC-0174-4122	
111	C-30	07-104A-2700	Bobbin Case Ass'y	Substitution	01. 10	07-004A-2700	
112	C-31	07-106A-127A	Bobbin Case Ass'y	Substitution	01. 10	07-006A-123A	
113	C-29	07-105A-2700	Bobbin Case(Steel)	Substitution	01. 10	07-008A-1230	
114	D-1	06-101A-250A	Feed Cam A	Substitution	01. 10	06-001A-250A	
115	D-2	SC-0129-7400	Screw(1/4" n=40)	Substitution	01. 10	SC-0129-4515	
116	D-3	06-101A-350A	Feed Cam A	Substitution	01. 10	06-001A-350A	
117	D-5	06-102A-2500	Feed Cam C	Substitution	01. 10	06-002A-2500	
118	D-6	06-102A-3500	Feed Cam C	Substitution	01. 10	06-002A-3500	
119	D-7	06-103A-2500	Feed Rocker Shaft Connecting Rod	Substitution	01. 10	06-003A-2500	
120	D-8	06-154A-1230	Crank Rod	Substitution	01. 10	06-054A-1230	

NOTE)

수정 리스트

Changed Parts List

No.	Ref. No.	Parts No.	Name of Parts	Contents	Date	Old Parts No.	Remarks
121	D-10	06-103A-2350	Feed Regulator Link	Substitution	01. 10	06-003A-2350	
122	D-11	06-104P-2350	Feed Connecting Link Pin(A)	Substitution	01. 10	06-004P-2350	
123	D-12	SC-0496-3710	Screw(11/64" n=40)	Substitution	01. 10	SC-0496-4122	
124	D-13	06-105A-2350	Feed Connection Link	Substitution	01. 10	06-005A-2350	
125	D-14	06-106A-2350	Feed Connection Link	Substitution	01. 10	06-006A-2350	
126	D-15	06-107P-2350	Feed Adjusting Link Hinge Pin(A)	Substitution	01. 10	06-007P-2350	
127	D-16	SC-0504-1230	Screw(1/4" n=40)	Substitution	01. 10	SC-0504-4515	
128	D-17	06-108P-2350	Feed Adjusting Link Hinge Pin(B)	Substitution	01. 10	06-008P-2350	
129	D-18	SC-0504-1230	Screw(1/4" n=40)	Substitution	01. 10	SC-0504-4515	
130	D-19	06-109P-2350	Feed Connecting Link Pin(B)	Substitution	01. 10	06-009P-2350	
131	D-21	06-110P-2350	Feed Connecting Link Pin(C)	Substitution	01. 10	06-010P-2350	
132	D-22	SC-0175-1230	Screw(11/64" n=40)	Substitution	01. 10	SC-0175-4522	
133	D-25	SC-0175-1230	Screw(11/64" n=40)	Substitution	01. 10	SC-0175-4522	
134	D-26	06-112A-2350	Feed Rock Shaft	Substitution	01. 10	06-012A-2350	
135	D-29	SC-0114-1230	Screw(15/64" n=28)	Substitution	01. 10	SC-0114-4515	
136	D-30	06-113A-2350	Feed Rock Shaft Bushing(F)	Substitution	01. 10	06-013A-2350	
137	D-31	SC-0114-1230	Screw(15/64" n=28)	Substitution	01. 10	SC-0114-4515	
138	D-34	SC-0307-1230	Screw(3/16" n=32)	Substitution	01. 10	SC-0307-4122	
139	D-35	06-114A-2350	Feed Bar Shaft	Substitution	01. 10	06-014A-2350	
140	D-38	SC-0133-1230	Screw(1/8" n=44)	Substitution	01. 10	SC-0133-4122	
141	D-40	SC-0122-1230	Screw(15/64" n=28)	Substitution	01. 10	SC-0122-4522	
142	D-44	SC-0130-1230	Screw(1/8" n=44)	Substitution	01. 10	SC-0130-4122	
143	D-45	06-117A-1230	Feed Bar Block and Shaft	Substitution	01. 10	06-017A-1230	
144	D-48	06-128A-2350	Feed Lifting Shaft Crank(F)	Substitution	01. 10	06-028A-2350	
145	D-50	SC-0497-1230	Screw(3/16" n=28)	Substitution	01. 10	SC-0497-4122	
146	D-51	06-116A-2350	Feed Lifting Shaft	Substitution	01. 10	06-016A-2350	
147	D-53	06-139A-1230	Feed Lifting Shaft Bushing(F)	Substitution	01. 10	06-039A-1230	
148	D-55	06-140A-1230	Feed Lifting Shaft Bushing(R)	Substitution	01. 10	06-040A-1230	
149	D-56	SC-0114-1230	Screw(15/64" n=28)	Substitution	01. 10	SC-0114-4515	
150	D-58	SC-0497-1230	Screw(3/16" n=28)	Substitution	01. 10	SC-0497-4122	
151	D-59	SC-0504-1230	Screw(1/4" n=40)	Substitution	01. 10	SC-0504-4515	
152	D-61	SC-0175-1230	Screw(11/64" n=40)	Substitution	01. 10	SC-0175-4522	
153	D-63	06-118A-2350	Feed Regulator Shaft	Substitution	01. 10	06-018A-2350	
154	D-65	SC-0507-1230	Screw(15/64" n=28)	Substitution	01. 10	SC-0507-4515	
155	D-66	06-119A-2350	Feed Regulator	Substitution	01. 10	06-019A-2350	
156	D-67	06-119A-1370	Feed Regulator	Substitution	01. 10	06-019A-1370	
157	D-68	SC-0174-1230	Screw(11/64" n=40)	Substitution	01. 10	SC-0174-4122	
158	D-69	06-220A-2350	Collar for D-63	Substitution	01. 10	06-020A-2350	
159	D-70	SC-0129-7400	Screw(1/4" n=40)	Substitution	01. 10	SC-0129-4515	
160	D-71	06-221A-2350	Feed Adjusting Shaft	Substitution	01. 10	06-021A-2350	

NOTE)

수정 리스트

Changed Parts List

No	Ref No	Parts No	Name of Parts	Contents	Date	Old Parts No	Remarks
161	D-72	06-112A-2500	Connecting Rod for Feed Regulator	Substitution	01. 10	06-022A-2500	
162	D-72-1	06-122A-1370	Connecting Rod for Feed Regulator	Substitution	01. 10	06-022A-1370	
163	D-75	SC-0158-3710	Screw(9/64" n=40)	Substitution	01. 10	SC-0158-4122	
164	D-78	06-125A-2500	Reverse Feed Control Lever Shaft	Substitution	01. 10	06-025A-2500	
165	D-82	SC-0184-1600	Screw(3/16" n=28)	Substitution	01. 10	SC-0184-4118	
166	D-83	SC-0174-1230	Screw(11/64" n=40)	Substitution	01. 10	SC-0174-4122	
167	D-87	SN-0101-1600	Nut(11/64" n=40)	Substitution	01. 10	SN-0101-4000	
168	D-91	SC-0193-1230	Screw(3/16" n=28)	Substitution	01. 10	SC-0193-4122	
169	D-96	SC-0166-2350	Screw(M5×0.8)	Substitution	01. 10	SC-0166-4119	
170	D-98	SC-0109-2350	Screw(M6)	Substitution	01. 10	SC-0109-4113	
171	D-105	SC-0175-1230	Screw(11/64" n=40)	Substitution	01. 10	SC-0175-4522	
172	D-109	SC-0186-1230	Screw(3/16" n=32)	Substitution	01. 10	SC-0186-4118	
173	D-110	SC-0185-1230	Screw(3/16" n=32)	Substitution	01. 10	SC-0185-4124	
174	D-116	SC-0497-1230	Screw(3/16" n=28)	Substitution	01. 10	SC-0497-4122	
175	D-117	06-129A-3500	Lever Feed Crank(R)	Substitution	01. 10	06-029A-3500	
176	D-118	SC-0327-3500	Screw(9/32" n=28)	Substitution	01. 10	SC-0327-4511	
177	D-119	SC-0496-3710	Screw(11/64" n=40)	Substitution	01. 10	SC-0496-4122	
178	D-42	06-107A-5060	Feed Dog 1/8"	Substitution	01. 10	06-007A-5060	
179	D-43	06-138A-5300	Feed Dog 1/8"	Substitution	01. 10	06-038A-5300	
180	E-4	SC-0137-2700	Screw(1/8" n=40)	Substitution	01. 10	SC-0137-4222	
181	E-5	SN-0103-2700	Nut(1/8" n=40)	Substitution	01. 10	SN-0103-4000	
182	E-7	SC-0543-2302	Screw(11/64" n=40)	Substitution	01. 10	SC-0543-4525	
183	E-17	SN-0101-1600	Nut(11/64" n=40)	Substitution	01. 10	SN-0101-4000	
184	E-19	SC-0108-2350	Screw(M6)	Substitution	01. 10	SC-0108-4113	
185	E-28	SN-0115-7400	Nut(3/16" n=32)	Substitution	01. 10	SN-0115-4000	
186	E-33	SN-0105-3400	Nut(15/64" n=28)	Substitution	01. 10	SN-0105-4000	
187	E-37	SC-0548-7400	Screw(3/16" n=28)	Substitution	01. 10	SC-0548-4122	
188	E-42	SN-0105-3400	Nut(15/64" n=28)	Substitution	01. 10	SN-0105-4000	
189	E-48	SN-0115-7400	Solenoid Connection Link	Substitution	01. 10	SN-0115-4000	
190	E-47	SC-0548-7400	Screw(3/16" n=28)	Substitution	01. 10	SC-0548-4122	
191	E-50	SC-0496-3710	Screw(11/64" n=40)	Substitution	01. 10	SC-0496-4122	
192	E-55	SC-0183-2700	Screw(15/64" n=28)	Substitution	01. 10	SC-0183-4122	
193	E-2	10-101A-2700	Fixed Mes	Substitution	01. 10	10-001A-2700	
194	E-9	10-106A-2700	Rotary Mes	Substitution	01. 10	10-002A-257A	
195	F-1	13-101A-5300	Mes Driving Rod	Substitution	01. 10	13-001A-5300	
196	F-4	13-104A-5300	Mes Driving Rod Link	Substitution	01. 10	13-004A-5300	
197	F-6	SC-0502-2302	Screw(9/64" n=40)	Substitution	01. 10	SC-0502-4125	
198	F-8	SC-0507-1230	Screw(15/64" n=28)	Substitution	01. 10	SC-0507-4515	
199	F-9	SC-0525-5300	Screw(11/64" n=40)	Substitution	01. 10	SC-0525-4122	
200	F-10	13-110A-5300	Mes Driving Link "A"	Substitution	01. 10	13-010A-5300	

NOTE)

수정 리스트

Changed Parts List

No.	Ref. No.	Parts No.	Name of Parts	Contents	Date	Old Parts No.	Remarks
201	F-11	SC-0525-5300	Screw(11/64" n=40)	Substitution	01. 10	SC-0525-4122	
202	F-12	13-112A-5300	Mes Driving Link "B"	Substitution	01. 10	13-012A-5300	
203	F-13	13-113A-5300	Mes Driving Link "C"	Substitution	01. 10	13-013A-5300	
204	F-15	SC-0531-2302	Screw(9/64" n=40)	Substitution	01. 10	SC-0531-4125	
205	F-16	SC-0525-5300	Screw(11/64" n=40)	Substitution	01. 10	SC-0525-4122	
206	F-19	SC-0497-1230	Screw(3/16" n=28)	Substitution	01. 10	SC-0497-4122	
207	F-23	SC-0497-1230	Screw(3/16" n=28)	Substitution	01. 10	SC-0497-4122	
208	F-30	SC-0183-2700	Screw(15/64" n=28)	Substitution	01. 10	SC-0183-4122	
209	F-35	SC-0548-7400	Screw(3/16" n=28)	Substitution	01. 10	SC-0548-4122	
210	F-38	13-138A-5300	Mes Driving Holder	Substitution	01. 10	13-038A-5300	
211	F-39	SC-0158-3710	Screw(9/64" n=40)	Substitution	01. 10	SC-0158-4122	
212	F-43	SC-0190-2700	Screw(3/16" n=32)	Substitution	01. 10	SC-0190-4111	
213	F-46	SC-0190-2700	Screw(3/16" n=32)	Substitution	01. 10	SC-0190-4111	
214	F-49	SC-0174-1230	Screw(11/64" n=40)	Substitution	01. 10	SC-0174-4122	
215	F-51-1	SC-0513-5050	Screw(1/8" n=44)	Substitution	01. 10	SC-0513-4515	
216	F-52	SC-0528-1230	Screw(9/64" n=40)	Substitution	01. 10	SC-0528-4125	
217	F-59	SC-0312-5050	Screw(1/8" n=44)	Substitution	01. 10	SC-0312-4125	
218	F-64	SC-0531-2302	Screw(9/64" n=40)	Substitution	01. 10	SC-0531-4125	
219	G-3	SC-0157-1230	Screw(9/64" n=40)	Substitution	01. 10	SC-0157-2118	
220	G-4	13-103A-3500	Needle Bar Frame Shaft Bushing	Substitution	01. 10	15-003A-3500	
221	G-5	SC-0352-7400	Screw(3/16" n=28)	Substitution	01. 10	SC-0352-4515	
222	G-7	SC-0184-1600	Screw(3/16" n=28)	Substitution	01. 10	SC-0184-4118	
223	G-11	SC-0159-3500	Screw(9/64" n=40)	Substitution	01. 10	SC-0159-4422	
224	G-13	SC-0497-1230	Screw(3/16" n=28)	Substitution	01. 10	SC-0497-4122	
225	G-15	15-112A-3500	Needle Feed Connection Shaft	Substitution	01. 10	15-012A-3500	
226	G-17	SC-0352-7400	Screw(3/16" n=28)	Substitution	01. 10	SC-0352-4515	
227	G-19	SC-0114-1230	Screw(15/64" n=28)	Substitution	01. 10	SC-0114-4515	
228	G-21	SC-0497-1230	Screw(3/16" n=28)	Substitution	01. 10	SC-0497-4122	
229	G-23	SN-0105-3400	Nut(15/64" n=28)	Substitution	01. 10	SN-0105-4000	
230	G-24	15-116A-3500	Needle Feed Connection Rod	Substitution	01. 10	16-016A-3500	
231	G-27	SN-0105-3400	Nut(15/64" n=28)	Substitution	01. 10	SN-0105-4000	
232	G-28	SC-0316-2350	Screw(11/64" n=40)	Substitution	01. 10	SC-0316-4124	
233	G-32	SC-0516-3500	Screw(3/16" n=28)	Substitution	01. 10	SC-0516-4119	
234	G-38	SC-0307-1230	Screw(3/16" n=32)	Substitution	01. 10	SC-0307-4122	
235	G-1	15-101A-3500	Needle Bar Frame	Substitution	01. 10	15-001A-3500	
236	H-1	SC-0339-1230	Screw(9/16" n=20)	Substitution	01. 10	SC-0339-4125	
237	H-5	05-206A-5300	Presser Bar	Substitution	01. 10	05-006A-5300	
238	H-6	05-115A-2500	Presser Bar Bushing	Substitution	01. 10	05-015A-2500	
239	H-7	05-108A-3500	Presser Bar Holder	Substitution	01. 10	05-008A-3500	
240	H-8	SC-0174-811H	Screw(11/64" n=40)	Substitution	01. 10	SC-0174-4122	

NOTE)

수정 리스트

Changed Parts List

No.	Ref. No.	Parts No.	Name of Parts	Contents	Date	Old Parts No.	Remarks
241	H-10	SC-0157-1230	Screw(9/64" n=40)	Substitution	01. 10	SC-0157-2118	
242	H-13	SC-0158-3710	Screw(9/64" n=40)	Substitution	01. 10	SC-0158-4122	
243	H-20	SC-0502-2302	Screw(9/64" n=40)	Substitution	01. 10	SC-0502-4125	
244	H-38	SC-0516-3500	Screw(3/16" n=28)	Substitution	01. 10	SC-0516-4119	
245	H-44	SC-0548-7400	Screw(3/16" n=28)	Substitution	01. 10	SC-0548-4122	
246	H-46	SC-0543-2302	Screw(11/64" n=40)	Substitution	01. 10	SC-0543-4525	
247	I-2	SC-0548-7400	Screw(3/16" n=28)	Substitution	01. 10	SC-0548-4122	
248	I-6	SC-0105-7500	Screw(M4)	Substitution	01. 10	SC-0105-4517	
249	I-10	SN-0101-1600	Nut(11/64" n=40)	Substitution	01. 10	SN-0101-4000	
250	I-13	SC-0531-2302	Screw(9/64" n=40)	Substitution	01. 10	SC-0531-4125	
251	I-15	SC-0548-7400	Screw(3/16" n=28)	Substitution	01. 10	SC-0548-4122	
252	I-17	SC-0120-1230	Screw(9/64" n=40)	Substitution	01. 10	SC-0120-2118	
253	I-19	SC-0196-2700	Screw(M3×0.5)	Substitution	01. 10	SC-0196-4118	
254	J-2	SC-0523-1230	Screw(9/64" n=40)	Substitution	01. 10	SC-0523-4122	
255	J-8	SC-0178-7400	Screw(11/64" n=40)	Substitution	01. 10	SC-0178-4118	
256	K-6	SC-0548-7400	Screw(3/16" n=28)	Substitution	01. 10	SC-0548-4122	
257	K-7-6	SC-0183-2700	Screw(15/64" n=28)	Substitution	01. 10	SC-0183-4122	
258	K-7-8	SN-0121-7400	Nut(15/64" n=28)	Substitution	01. 10	SN-0121-400	
259	K-7-10	SC-0497-1230	Screw(3/16" n=28)	Substitution	01. 10	SC-0497-4122	
260	K-8-5	SC-0512-1230	Screw(11/64" n=40)	Substitution	01. 10	SC-0512-4515	
261	L-6	SC-0120-1230	Screw(9/64" n=40)	Substitution	01. 10	SC-0120-2118	
262	L-10	SC-0548-7400	Screw(3/16" n=28)	Substitution	01. 10	SC-0548-4122	
263	L-14-3	SC-0528-1230	Screw(9/64" n=40)	Substitution	01. 10	SC-0528-4125	
264	L-14-14	SC-0120-1230	Screw(9/64" n=40)	Substitution	01. 10	SC-0120-2118	
265	L-14-15	44-119A-1230	Collar for Impeller Shaft	Substitution	01. 10	44-019A-1230	
266	L-14-16	SC-0512-1230	Screw(11/64" n=40)	Substitution	01. 10	SC-0512-4515	
267	L-16	SC-0548-7400	Screw(3/16" n=28)	Substitution	01. 10	SC-0548-4122	
268	L-18	44-115A-1230	Oil Pump Connecting Collar	Substitution	01. 10	44-015A-1230	
269	L-19	SC-0542-1230	Screw(11/64" n=40)	Substitution	01. 10	SC-0542-4515	
270	M-25	SC-0344-8260	Screw(5/16" n=24)	Substitution	01. 10	SC-0344-4125	
271	M-27	SC-0184-1600	Screw(3/16" n=28)	Substitution	01. 10	SC-0184-4118	
272	M-33	SC-0347-1230	Screw(M8×1.25)	Substitution	01. 10	SC-0347-4122	
273	M-35-7	SC-0181-1230	Screw(5/16" n=18)	Substitution	01. 10	SC-0181-4116	
274	M-39	SC-0106-7400	Screw(15/64" n=28)	Substitution	01. 10	SC-0106-4111	
275	M-40	SC-0545-1230	Screw(15/64" n=28)	Substitution	01. 10	SC-0545-4518	
276	M-42	SN-0105-3400	Nut(15/64" n=28)	Substitution	01. 10	SN-0105-4000	
277	M-48	SC-0543-2302	Screw(11/64" n=40)	Substitution	01. 10	SC-0543-4525	
278	M-49-5	SC-0525-5300	Screw(11/64" n=40)	Substitution	01. 10	SC-0525-4122	
279	M-49-6	SN-0101-1600	Nut(11/64" n=40)	Substitution	01. 10	SN-0101-4000	
280	C-20	07-107A-250A	Lower Shaft Bushing(F)	Substitution	02. 04	07-007A-250A	

NOTE)

수정 리스트 Changed Parts List

No	Ref. No	Parts No	Name of Parts	Contents	Date	Old Parts No	Remarks
281	G-8	15-105A-3500	Needle Bearing	Substitution	02. 04	15-005A-3500	
282	A-35	01-045A-5307	Sub Needle Plate	Change of Blue Point	02. 01	01-045A-5300	02. 1/4
283	M-46	01-050A-5300	Sub Needle Plate Cover	Change of Blue Point	02. 01	01-050A-5300	02. 1/4
284	C-7	03-103A-1230	Upper Shaft Lower B/S	Substitution	02. 01	03-003A-1600	02. 1/4
285	B-27	08-201A-250A	Thread Take Up Lever Ass'y	Substitution	02. 01	08-001A-250A	02. 1/4
286	N-3	02-101A-537N	Main Shaft	Substitution	02. 01	02-001A-537N	02. 1/4
287	A-13	01-241M-2500	Gasket For Back Cover	Substitution	02. 01	01-041M-2500	02. 1/4
288	C-10	07-103A-257A	Lower Shaft	Substitution	02. 02	07-003A-257A	02. 1/4
289	F-47	SN-0105-3400	Nut	Substitution	02. 02	13-025A-5300	02. 1/4
290	A-33	01-136S-1230	Screw For Needle Plate	Substitution	02. 02	01-037S-5060	02. 1/4
291	A-36	01-136S-1230	Screw For Needle Plate	Substitution	02. 02	01-037S-5060	02. 1/4
292	D-41	06-215A-2350	Feed Bar	Substitution	02. 02	06-015A-2350	02. 1/4
293	M-6	07-105A-2700	Bobbin	Additional Parts	02. 02	07-106A-2700	02. 1/4
294	M-8	91-105C-2700	Spanner	Substitution	02. 06	91-005C-2700	02. 2/4
295	H-45	40-210A-257A	Tension Release Cable Holder	Substitution	02. 06	40-010A-257A	02. 2/4
296	E-38	10-125A-257A	Thread Trimming Cam	Substitution	02. 06	10-025A-257A	02. 2/4
297	E-40	10-126A-257A	Clutch Lever	Substitution	02. 06	10-026A-257A	02. 2/4
298	H-22	43-106C-2500	Presser Lifter Connection Bar	Substitution	02. 06	43-006C-2500	02. 2/4
299	H-24	43-108A-2500	Knee Lifting Link	Substitution	02. 06	43-008A-2500	02. 2/4
300	H-27	43-109C-2500	Knee Lifting Bar	Substitution	02. 06	43-009C-2500	02. 2/4
301	D-95	06-130A-257A	Bracket For Reverse Feed Solenoid	Substitution	02. 06	06-030A-257A	02. 2/4
302	A-8	01-139C-2500	Take Up Lever Cover	Substitution	02. 06	01-039C-2500	02. 2/4
303	B-33	08-106C-2500	Protection Plate	Substitution	02. 06	08-006C-2500	02. 2/4
304	H-14	43-102A-2500	Cam Shaft For Presser Bar	Substitution	02. 06	43-002A-2500	02. 2/4
305	H-16	43-103A-2500	Presser Lifter Link	Substitution	02. 06	43-003A-2500	02. 2/4
306	A-21	01-115C-1230	Bed Leg Right	Substitution	02. 06	01-015C-1230	02. 2/4
307	H-21	43-106C-3500	Presser Lifter Lever	Substitution	02. 06	43-006C-3500	02. 2/4
308	H-25	43-108A-3500	Knee Lifting Link	Substitution	02. 06	43-108A-3500	02. 2/4
309	J-5	12-104P-5607	Reverse Button Actuator Pin	Substitution	02. 06	12-004P-5607	02. 2/4
310	A-46	40-201A-2700	Supplementary Tension Control Ass'y	Substitution	02. 06	40-001A-2700	02. 2/4
311	H-37	40-109A-257A	Cable Holder(U)	Substitution	02. 06	40-009A-257A	02. 2/4
312	E-36	10-124C-257A	Spring Holder	Substitution	02. 06	10-024C-257A	02. 2/4
313	E-48	10-130A-257A	Solenoid Connection Link	Substitution	02. 06	10-030A-257A	02. 2/4
314	A-26	01-142A-257A	Code Holder "A"	Substitution	02. 06	01-042A-257A	02. 2/4
315	A-27	01-143A-257A	Code Holder "B"	Substitution	02. 06	01-043A-257A	02. 2/4
316	E-21	10-116W-257A	Thread Trimming Shaft Washer	Substitution	02. 06	10-016W-257A	02. 2/4
317	E-34	10-122P-257A	Stopper Pin	Substitution	02. 06	10-022P-257A	02. 2/4
318	L-14-13	44-105C-2500	Magnetic Holder	Substitution	02. 06	44-005C-2500	02. 2/4
319	A-44	01-116A-2350	Guide Bar	Substitution	02. 06	01-016A-2350	02. 2/4
320	L-4	44-131C-1230	Arm Oil Shield	Substitution	02. 06	44-031C-1230	02. 2/4

NOTE)

수정 리스트
Changed Parts List

No.	Ref. No.	Parts No.	Name of Parts	Contents	Date	Old Parts No.	Remarks
301	A-34	01-434A-1230	Slide Plate	Substitution	02. 06	01-034A-1230	02. 2/4
302	G-6	15-104A-3500	Slide Block Guide	Substitution	02. 08	15-004A-3500	02. 3/4
303	M-46	01-050A-5307	Sub Needle Plate Cover	Substitution	02. 09	01-050A-5307	02. 3/4
304	F-48	13-147A-5300	Mes Position Adjusting Plate	Substitution	02. 09	13-047A-5300	02. 3/4
305							
306							
307							
308							
309							
310							
311							
312							
313							
314							
315							
316							
317							
318							
319							
320							
321							
322							
323							
324							
325							
326							
327							
328							
329							
330							
331							
332							
333							
334							
335							
336							
337							
338							
339							
340							

NOTE)

